

**A88XM-PLUS**

**ASUS**<sup>®</sup>

**Motherboard**

E8561  
First Edition  
August 2013

**Copyright © 2013 ASUSTeK COMPUTER INC. All Rights Reserved.**

No part of this manual, including the products and software described in it, may be reproduced, transmitted, transcribed, stored in a retrieval system, or translated into any language in any form or by any means, except documentation kept by the purchaser for backup purposes, without the express written permission of ASUSTeK COMPUTER INC. ("ASUS").

Product warranty or service will not be extended if: (1) the product is repaired, modified or altered, unless such repair, modification or alteration is authorized in writing by ASUS; or (2) the serial number of the product is defaced or missing.

ASUS PROVIDES THIS MANUAL "AS IS" WITHOUT WARRANTY OF ANY KIND, EITHER EXPRESS OR IMPLIED, INCLUDING BUT NOT LIMITED TO THE IMPLIED WARRANTIES OR CONDITIONS OF MERCHANTABILITY OR FITNESS FOR A PARTICULAR PURPOSE. IN NO EVENT SHALL ASUS, ITS DIRECTORS, OFFICERS, EMPLOYEES OR AGENTS BE LIABLE FOR ANY INDIRECT, SPECIAL, INCIDENTAL, OR CONSEQUENTIAL DAMAGES (INCLUDING DAMAGES FOR LOSS OF PROFITS, LOSS OF BUSINESS, LOSS OF USE OR DATA, INTERRUPTION OF BUSINESS AND THE LIKE), EVEN IF ASUS HAS BEEN ADVISED OF THE POSSIBILITY OF SUCH DAMAGES ARISING FROM ANY DEFECT OR ERROR IN THIS MANUAL OR PRODUCT.

SPECIFICATIONS AND INFORMATION CONTAINED IN THIS MANUAL ARE FURNISHED FOR INFORMATIONAL USE ONLY, AND ARE SUBJECT TO CHANGE AT ANY TIME WITHOUT NOTICE, AND SHOULD NOT BE CONSTRUED AS A COMMITMENT BY ASUS. ASUS ASSUMES NO RESPONSIBILITY OR LIABILITY FOR ANY ERRORS OR INACCURACIES THAT MAY APPEAR IN THIS MANUAL, INCLUDING THE PRODUCTS AND SOFTWARE DESCRIBED IN IT.

Products and corporate names appearing in this manual may or may not be registered trademarks or copyrights of their respective companies, and are used only for identification or explanation and to the owners' benefit, without intent to infringe.

**Offer to Provide Source Code of Certain Software**

This product contains copyrighted software that is licensed under the General Public License ("GPL"), under the Lesser General Public License Version ("LGPL") and/or other Free Open Source Software Licenses. Such software in this product is distributed without any warranty to the extent permitted by the applicable law. Copies of these licenses are included in this product.

Where the applicable license entitles you to the source code of such software and/or other additional data, you may obtain it for a period of three years after our last shipment of the product, either

(1) for free by downloading it from <http://support.asus.com/download>  
or

(2) for the cost of reproduction and shipment, which is dependent on the preferred carrier and the location where you want to have it shipped to, by sending a request to:

ASUSTeK Computer Inc.  
Legal Compliance Dept.  
15 Li Te Rd.,  
Beitou, Taipei 112  
Taiwan

In your request please provide the name, model number and version, as stated in the About Box of the product for which you wish to obtain the corresponding source code and your contact details so that we can coordinate the terms and cost of shipment with you.

The source code will be distributed WITHOUT ANY WARRANTY and licensed under the same license as the corresponding binary/object code.

This offer is valid to anyone in receipt of this information.

ASUSTeK is eager to duly provide complete source code as required under various Free Open Source Software licenses. If however you encounter any problems in obtaining the full corresponding source code we would be much obliged if you give us a notification to the email address [gpl@asus.com](mailto:gpl@asus.com), stating the product and describing the problem (please DO NOT send large attachments such as source code archives, etc. to this email address).

# Contents

Safety information .....	iv
About this guide .....	iv
Package contents .....	vi
A88XM-PLUS specifications summary .....	vi

## Product introduction

1.1 Before you proceed .....	1-1
1.2 Motherboard overview .....	1-2
1.3 Accelerated Processing Unit (APU) .....	1-4
1.4 System memory .....	1-8
1.5 Expansion slots.....	1-10
1.6 Jumpers .....	1-12
1.7 Onboard switches .....	1-14
1.8 Onboard LEDs .....	1-15
1.9 Connectors .....	1-16
1.10 Software support.....	1-26

## BIOS information

2.1 Managing and updating your BIOS .....	2-1
2.2 BIOS setup program .....	2-6
2.3 My Favorites .....	2-9
2.4 Main menu .....	2-10
2.5 Ai Tweaker menu.....	2-12
2.6 Advanced menu .....	2-17
2.7 Monitor menu .....	2-24
2.8 Boot menu .....	2-27
2.9 Tools menu .....	2-34
2.10 Exit menu .....	2-35

## Appendices

Notices.....	A-1
ASUS contact information .....	A-3

# Safety information

## Electrical safety

- To prevent electrical shock hazard, disconnect the power cable from the electrical outlet before relocating the system.
- When adding or removing devices to or from the system, ensure that the power cables for the devices are unplugged before the signal cables are connected. If possible, disconnect all power cables from the existing system before you add a device.
- Before connecting or removing signal cables from the motherboard, ensure that all power cables are unplugged.
- Seek professional assistance before using an adapter or extension cord. These devices could interrupt the grounding circuit.
- Ensure that your power supply is set to the correct voltage in your area. If you are not sure about the voltage of the electrical outlet you are using, contact your local power company.
- If the power supply is broken, do not try to fix it by yourself. Contact a qualified service technician or your retailer.

## Operation safety

- Before installing the motherboard and adding components, carefully read all the manuals that came with the package.
- Before using the product, ensure all cables are correctly connected and the power cables are not damaged. If you detect any damage, contact your dealer immediately.
- To avoid short circuits, keep paper clips, screws, and staples away from connectors, slots, sockets and circuitry.
- Avoid dust, humidity, and temperature extremes. Do not place the product in any area where it may be exposed to moisture.
- Place the product on a stable surface.
- If you encounter technical problems with the product, contact a qualified service technician or your retailer.

## About this guide

This user guide contains the information you need when installing and configuring the motherboard.

## How this guide is organized

This guide contains the following parts:

- **Chapter 1: Product introduction**  
This chapter describes the features of the motherboard and the new technology it supports. It includes descriptions of the switches, jumpers, and connectors on the motherboard.
- **Chapter 2: BIOS information**  
This chapter discusses changing system settings through the BIOS Setup menus. Detailed descriptions of the BIOS parameters are also provided.

## Where to find more information

Refer to the following sources for additional information and for product and software updates.

### 1. ASUS websites

The ASUS website provides updated information on ASUS hardware and software products. Refer to the ASUS contact information.

### 2. Optional documentation

Your product package may include optional documentation, such as warranty flyers, that may have been added by your dealer. These documents are not part of the standard package.

## Conventions used in this guide

To ensure that you perform certain tasks properly, take note of the following symbols used throughout this manual.



**DANGER/WARNING:** Information to prevent injury to yourself when completing a task.



**CAUTION:** Information to prevent damage to the components when completing a task.



**IMPORTANT:** Instructions that you **MUST** follow to complete a task.



**NOTE:** Tips and additional information to help you complete a task.

## Typography

**Bold text**

Indicates a menu or an item to select.

*Italics*

Used to emphasize a word or a phrase.

<Key>

Keys enclosed in the less-than and greater-than sign means that you must press the enclosed key.

Example: <Enter> means that you must press the Enter or Return key.

<Key1> + <Key2> + <Key3>

If you must press two or more keys simultaneously, the key names are linked with a plus sign (+).

## Package contents

Check your motherboard package for the following items.

<b>Motherboard</b>	ASUS A88XM-PLUS motherboard
<b>Cables</b>	2 x Serial ATA 6.0 Gb/s cables
<b>Accessories</b>	1 x I/O Shield
<b>Application DVD</b>	Support DVD
<b>Documentation</b>	User Manual



If any of the above items is damaged or missing, contact your retailer.

## A88XM-PLUS specifications summary

<b>APU</b>	<p>AMD® FM2+ socket for AMD® A-Series/Athlon series processors</p> <p>Supports CPU up to 4 cores</p> <p>AMD® Turbo Core Technology 3.0 support</p> <ul style="list-style-type: none"> <li>• The AMD® Turbo Core Technology 3.0 support depends on the APU types.</li> <li>• Refer to <a href="http://www.asus.com">www.asus.com</a> for the AMD® APU support list.</li> </ul>
<b>Chipset</b>	AMD® A88X FCH
<b>Memory</b>	<p>4 x 240-pin DIMM slots support maximum 64GB unbuffered non-ECC DDR3 2400(O.C.)/2250(O.C.)/2200(O.C.)/2133/1866/1600/1333 MHz memory modules</p> <p>Dual-channel memory architecture</p> <p>Supports AMD Memory Profile (AMP) memory</p> <ul style="list-style-type: none"> <li>• Hyper DIMM support is subject to the physical characteristics of individual APUs.</li> <li>• The maximum 64GB memory capacity can be supported with 16GB or above DIMMs. ASUS will update the memory QVL once the DIMMs are available in the market.</li> <li>• Refer to <a href="http://www.asus.com">www.asus.com</a> for the latest Memory QVL (Qualified Vendors List).</li> </ul>
<b>Graphics</b>	<p>Integrated AMD Radeon™ HD 8000/7000 Series Graphics in A-Series APU</p> <p>Multi-VGA output support: HDMI, DVI, RGB ports</p> <ul style="list-style-type: none"> <li>- Supports HDMI with max. resolution of 4096x2160@24Hz/1920x1200@60Hz</li> <li>- Supports DVI with max. resolution of 2560x1600@60Hz</li> <li>- Supports RGB with max. resolution of 1920x1600@60Hz</li> <li>- Maximum shared memory of 2048MB</li> <li>- Supports AMD® Dual Graphics technology</li> </ul> <ul style="list-style-type: none"> <li>• Refer to <a href="http://www.amd.com/us/products/technologies/dual-graphics/Pages/dual-graphics.aspx#3">http://www.amd.com/us/products/technologies/dual-graphics/Pages/dual-graphics.aspx#3</a> for the discrete GPUs that support Dual Graphics technology.</li> <li>• Only FM2+ APU can support up to 4096x2160 resolution display via HDMI port.</li> </ul>
<b>Multi-GPU Support</b>	Supports AMD Quad-GPU CrossFireX™ Technology
<b>Expansion slots</b>	<p>1 x PCIe 3.0/2.0 x16 slot*</p> <p>1 x PCIe 2.0 x16 slot (@x4 mode)</p> <p>1 x PCI Express 2.0 x1 slot</p> <p>1 x PCI slot</p> <p>* Only FM2+ processors can support PCIe 3.0.</p>

(continued on the next page)

## A88XM-PLUS specifications summary

Storage	<b>AMD® A88X FCH:</b> <ul style="list-style-type: none"> <li>- 8 x Serial ATA 6 Gb/s connectors with RAID 0, RAID 1, RAID 5, RAID 10 and JBOD support</li> </ul>
LAN	Realtek® 8111G PCIe Gigabit LAN controller
Audio	Realtek® ALC887 8-Channel High Definition Audio CODEC <ul style="list-style-type: none"> <li>- Supports Jack-Detection, Multi-Streaming and Front Panel Jack-Retasking</li> <li>• <b>Use a chassis with HD audio module in the front panel to support an 8-channel audio output.</b></li> </ul>
USB	<b>AMD® A88X FCH:</b> <ul style="list-style-type: none"> <li>- 4 x USB 3.0 ports* (2 ports at the back panel [blue], 2 ports at mid-board)</li> <li>- 10 x USB 2.0 ports (4 ports at the back panel, 6 ports at mid-board)</li> </ul> <b>* Supports ASUS USB 3.0 Boost</b>
ASUS unique features	<b>ASUS 5X Protection</b> <ul style="list-style-type: none"> <li>- ASUS motherboards safeguard your PC with 5X Protection: DIGI+VRM, DRAM Fuse, ESD Guards, High-Quality Solid Capacitors, and Stainless Steel Back I/O to ensure the best quality, reliability, and durability.</li> </ul> <b>ASUS DIGI+ VRM</b> <ul style="list-style-type: none"> <li>- DIGI+ VRM: Digital Power Design for the APU</li> <li>- DIGI 4+2 Phase Power Design</li> </ul> <b>ASUS DRAM Fuse</b> <ul style="list-style-type: none"> <li>- Enhanced DRAM overcurrent protection and short circuit damage prevention</li> </ul> <b>ASUS ESD Guard</b> <ul style="list-style-type: none"> <li>- Strong ESD Protection for extended component lifespan</li> </ul> <b>ASUS High-Quality Solid Capacitors</b> <ul style="list-style-type: none"> <li>- 2.5x Long Lifespan with excellent durability</li> </ul> <b>ASUS Stainless Steel Back I/O</b> <ul style="list-style-type: none"> <li>- 3x More durable corrosion-resistant coating</li> </ul> <b>ASUS Exclusive Features</b> <ul style="list-style-type: none"> <li>- ASUS EPU</li> <li>- ASUS GPU Boost</li> <li>- ASUS TurboV EVO</li> <li>- ASUS MemOK!</li> <li>- ASUS AI Suite 3</li> <li>- ASUS AI Charger</li> <li>- ASUS Anti Surge</li> <li>- ASUS UEFI BIOS EZ Mode featuring a friendly graphical user interface</li> <li>- ASUS Network iControl*</li> <li>- ASUS USB 3.0 Boost</li> <li>- ASUS Disk Unlocker</li> </ul> <b>* ASUS Network iControl feature is not supported on Windows® XP/Vista operating systems.</b>

(continued on the next page)

## A88XM-PLUS specifications summary

<b>ASUS unique features</b>	<b>ASUS Quiet Thermal Solution</b> <ul style="list-style-type: none"> <li>- Stylish Fanless Design Heat-sink solution &amp; MOS Heatsink</li> <li>- ASUS Fan Xpert 2</li> </ul> <b>ASUS EZ DIY</b> <ul style="list-style-type: none"> <li>- ASUS CrashFree BIOS 3</li> <li>- ASUS EZ Flash 2</li> <li>- ASUS My Logo 2</li> </ul> <b>ASUS Q-Design</b> <ul style="list-style-type: none"> <li>- ASUS Q-Slot</li> </ul>
<b>Back panel I/O ports</b>	1 x PS/2 keyboard port 1 x PS/2 mouse port 1 x HDMI port 1 x DVI port 1 x D-Sub output port 1 x LAN (RJ-45) port 2 x USB 3.0 ports (blue) 4 x USB 2.0/1.1 ports 8-channel audio I/O ports (3 jacks)
<b>Internal I/O connectors</b>	1 x USB 3.0 connector supports additional 2 USB 3.0 ports (19-pin) 3 x USB 2.0 connectors support additional 6 USB 2.0 ports 1 x TPM connector 1 x LPT connector 1 x COM Port connector 8 x SATA 6Gb/s connectors 1 x CPU fan connector (4-pin) 2 x Chassis fan connector (4-pin) 1 x S/PDIF Out connector 1 x 24-pin EATX power connector 1 x 4-pin ATX 12V power connector 1 x Front panel audio connector (AAFP) 1 x System panel 1 x MemOK! button 1 x GPU Boost switch
<b>BIOS features</b>	64 Mb Flash ROM, UEFI AMI BIOS, PnP, DMI 2.0, WfM 2.0, SM BIOS 2.7, ACPI 2.0a, Multi-language BIOS, ASUS EZ Flash 2, ASUS CrashFree BIOS 3, F12 Printscreen function, F3 Shortcut function and ASUS DRAM SPD (Serial Presence Detect) memory information

(continued on the next page)



# A88XM-PLUS specifications summary

<b>Operating System</b>	Windows® 8 / 8 64-bit Windows® 7 / 7 64-bit Windows® XP
<b>Support DVD</b>	Drivers ASUS utilities ASUS Update Anti-virus software (OEM version)
<b>Form factor</b>	uATX form factor: 9.6 in x 9.2 in (24.4 cm x 23.4 cm)



---

Specifications are subject to change without notice.

---



# Product introduction

# 1

## 1.1 Before you proceed

Take note of the following precautions before you install motherboard components or change any motherboard settings.



- Unplug the power cord from the wall socket before touching any component.
- Before handling components, use a grounded wrist strap or touch a safely grounded object or a metal object, such as the power supply case, to avoid damaging them due to static electricity.
- Hold components by the edges to avoid touching the ICs on them.
- Whenever you uninstall any component, place it on a grounded antistatic pad or in the bag that came with the component.
- Before you install or remove any component, ensure that the ATX power supply is switched off or the power cord is detached from the power supply. Failure to do so may cause severe damage to the motherboard, peripherals, or components.

### Standby Power LED

The motherboard comes with a standby power LED that lights up to indicate that the system is ON, in sleep mode, or in soft-off mode. This is a reminder that you should shut down the system and unplug the power cable before removing or plugging in any motherboard component. The illustration below shows the location of the onboard LED.

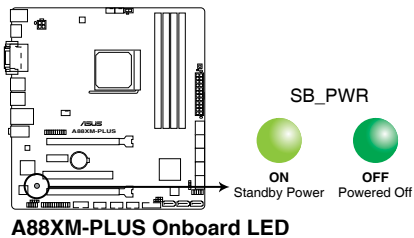

## 1.2 Motherboard overview

Before you install the motherboard, study the configuration of your chassis to ensure that the motherboard fits.



Unplug the power cord before installing or removing the motherboard. Failure to do so can cause you physical injury and damage to motherboard components.

### 1.2.1 Placement direction

When installing the motherboard, place it into the chassis in the correct orientation. The edge with external ports goes to the rear part of the chassis as indicated in the image.

### 1.2.2 Screw holes

Place six screws into the holes indicated by circles to secure the motherboard to the chassis.



Do not overtighten the screws! Doing so can damage the motherboard.

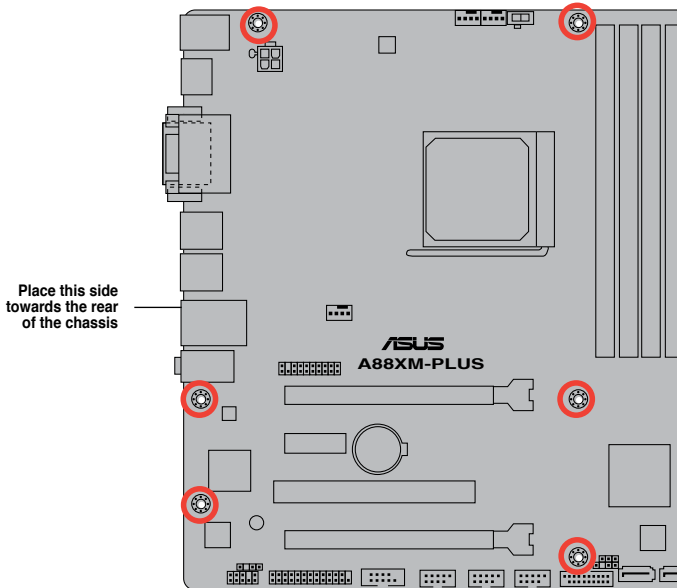

## 1.2.3 Motherboard layout

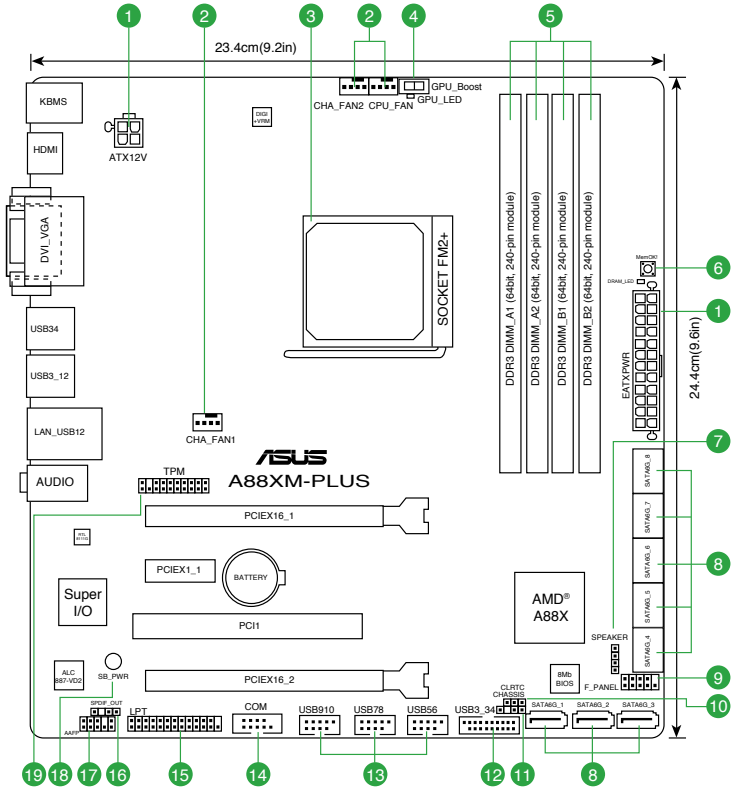

## 1.2.4 Layout contents

Connectors/Jumpers/Slots/LED	Page
1. ATX power connectors (24-pin EATXPWR, 4-pin ATX12V)	1-19
2. CPU and chassis fan connectors (4-pin CPU_FAN, and 4-pin CHA_FAN)	1-18
3. AMD FM2+ socket	1-4
4. GPU Boost switch	1-15
5. DDR3 DIMM slots	1-8
6. MemOK! button	1-14
7. Speaker connector (4-pin SPEAKER)	1-21
8. SATA 6.0 Gb/s connectors (7-pin SATA6G_1~8)	1-20
9. System panel connector (10-1 pin F_PANEL)	1-21
10. Clear RTC RAM (3-pin CLRTC)	1-12
11. Chassis intrusion connector (4-1 pin CHASSIS)	1-13
12. USB 3.0 connector (20-1 pin USB3_34)	1-23
13. USB 2.0 connectors (10-1 pin USB910, USB78, USB56)	1-23
14. Serial port connector (10-1 pin COM)	1-24
15. LPT connector (26-1 pin LPT)	1-25
16. Digital audio connector (4-1 pin SPDIF_OUT)	1-22
17. Front panel audio connector (10-1 pin AAFP)	1-22
18. Standby power LED (SB_PWR)	1-1
19. TPM connector (20-1 pin TPM)	1-24

## 1.3 Accelerated Processing Unit (APU)

This motherboard comes with a FM2+ socket designed for AMD® A-series and Athlon™ series processors.



Ensure that you use an APU designed for the FM2+ socket. The APU fits in only one correct orientation. DO NOT force the APU into the socket to prevent bending the pins and damaging the APU!

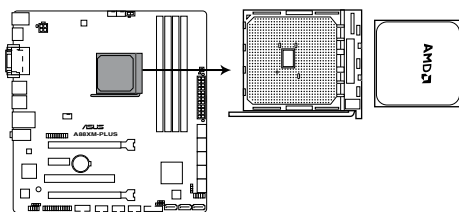

**A88XM-PLUS CPU socket FM2+**

### 1.3.1 APU installation

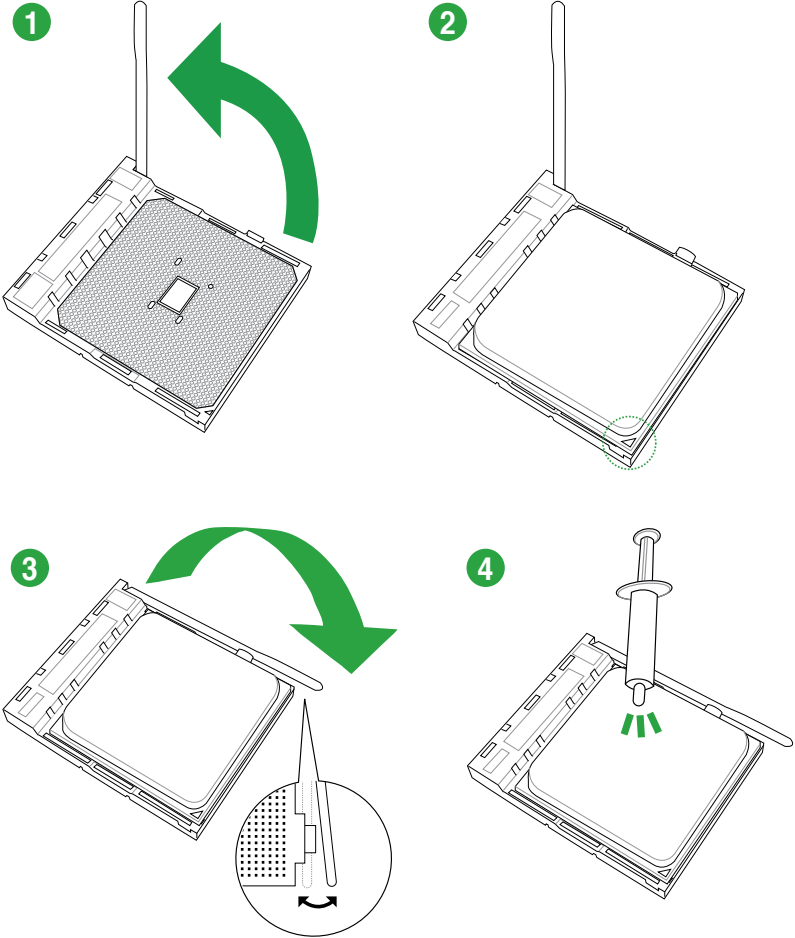

## 1.3.2 APU heatsink and fan assembly installation

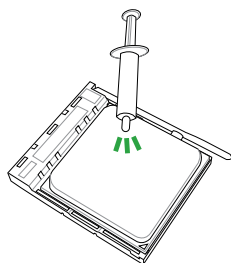

Apply the Thermal Interface Material to the APU heatsink and APU before you install the heatsink and fan if necessary.

### To install the APU heatsink and fan assembly

1

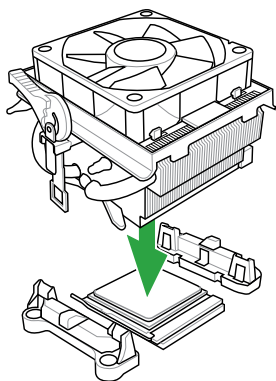

2

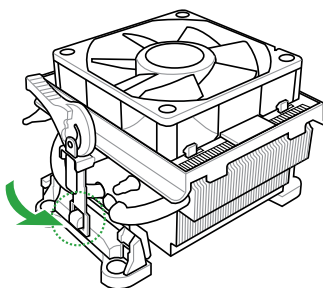

3

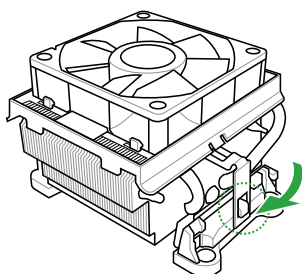

4

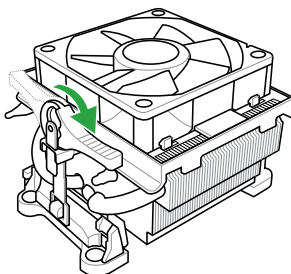

5

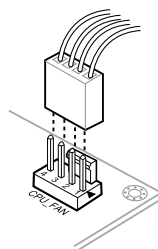



## To uninstall the APU heatsink and fan assembly

1

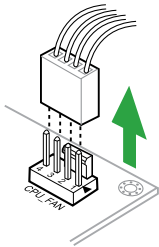

2

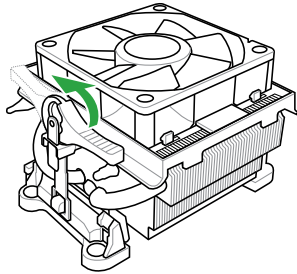

3

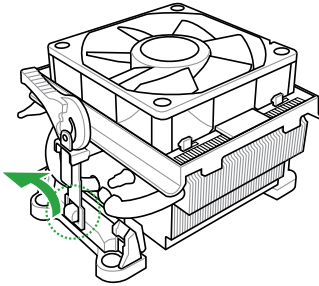

4

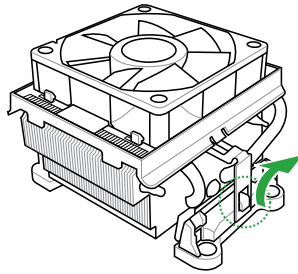

5

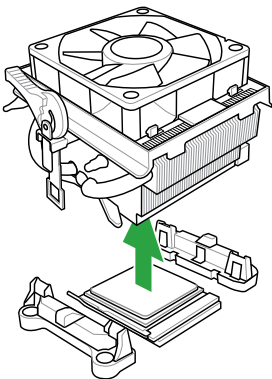

# 1.4 System memory

## 1.4.1 Overview

This motherboard comes with four Double Data Rate 3 (DDR3) Dual Inline Memory Modules (DIMM) sockets.

A DDR3 module has the same physical dimensions as a DDR2 DIMM but is notched differently to prevent installation on a DDR2 DIMM socket. DDR3 modules are developed for better performance with less power consumption.

The figure illustrates the location of the DDR3 DIMM sockets:

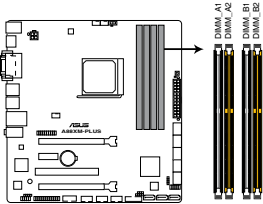

**A88XM-PLUS 240-pin DDR3 DIMM sockets**

Channel	Sockets
Channel A	DIMM_A1 and DIMM_A2
Channel B	DIMM_B1 and DIMM_B2

## 1.4.2 Memory configurations

You may install 1GB, 2GB, 4GB, and 8GB unbuffered non-ECC DDR3 DIMMs into the DIMM sockets.



- You may install varying memory sizes in Channel A and Channel B. The system maps the total size of the lower-sized channel for the dual-channel configuration. Any excess memory from the higher-sized channel is then mapped for single-channel operation.
- Always install DIMMs with the same CAS latency. For optimal compatibility, we recommend that you install memory modules of the same version or date code (D/C) from the same vendor. Check with the retailer to get the correct memory modules.
- Due to the memory address limitation on 32-bit Windows® OS, when you install 4GB or more memory on the motherboard, the actual usable memory for the OS can be about 3GB or less. For effective use of memory, we recommend that you do any of the following:
  - Use a maximum of 3GB system memory if you are using a 32-bit Windows® OS.
  - Install a 64-bit Windows® OS if you want to install 4GB or more on the motherboard.
- This motherboard does not support DIMMs made up of 512Mb (64MB) chips or less.



- The default memory operation frequency is dependent on its Serial Presence Detect (SPD), which is the standard way of accessing information from a memory module. Under the default state, some memory modules for overclocking may operate at a lower frequency than the vendor-marked value. To operate at the vendor-marked or at a higher frequency, refer to section 2.5 **Ai Tweaker** menu for manual memory frequency adjustment.
- For system stability, use a more efficient memory cooling system to support a full memory load (4 DIMMs) or overclocking condition.
- Visit the ASUS website at: [www.asus.com](http://www.asus.com) for the latest QVL.

### 1.4.3 Installing a DIMM

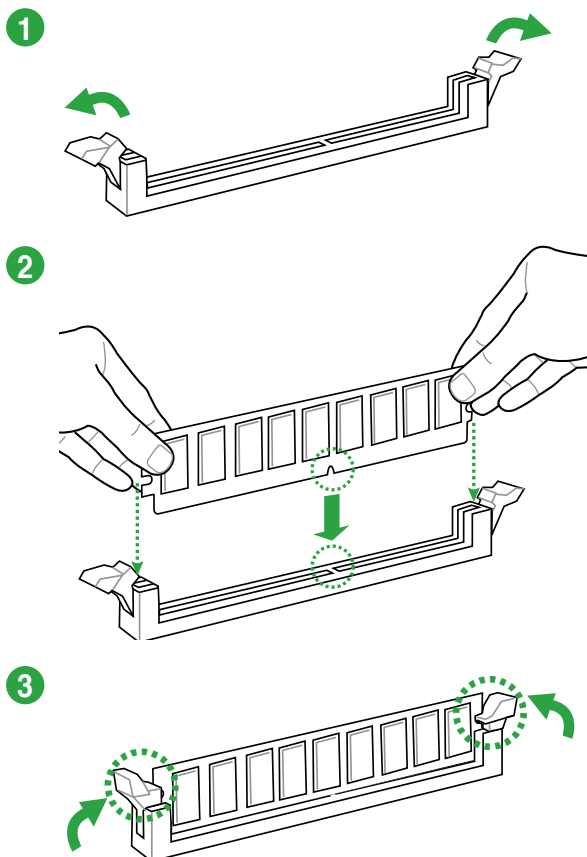

## To remove a DIMM

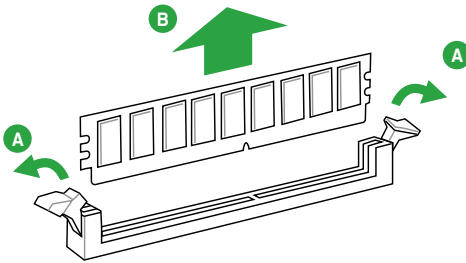

## 1.5 Expansion slots

In the future, you may need to install expansion cards. The following sub-sections describe the slots and the expansion cards that they support.



---

Unplug the power cord before adding or removing expansion cards. Failure to do so may cause you physical injury and damage motherboard components.

---

### 1.5.1 Installing an expansion card

**To install an expansion card:**

1. Before installing the expansion card, read the documentation that came with it and make the necessary hardware settings for the card.
2. Remove the system unit cover (if your motherboard is already installed in a chassis).
3. Remove the bracket opposite the slot that you intend to use. Keep the screw for later use.
4. Align the card connector with the slot and press firmly until the card is completely seated on the slot.
5. Secure the card to the chassis with the screw you removed earlier.
6. Replace the system cover.

### 1.5.2 Configuring an expansion card

After installing the expansion card, configure it by adjusting the software settings.

1. Turn on the system and change the necessary BIOS settings, if any. See Chapter 2 for information on BIOS setup.
2. Assign an IRQ to the card.
3. Install the software drivers for the expansion card.



---

When using PCI cards on shared slots, ensure that the drivers support "Share IRQ" or that the cards do not need IRQ assignments. Otherwise, conflicts will arise between the two PCI groups, making the system unstable and the card inoperable.

---

### 1.5.3 PCI slot

The PCI slot supports cards such as a LAN card, SCSI card, USB card, and other cards that comply with PCI specifications.

### 1.5.4 PCI Express 2.0 x1 slot

This motherboard supports PCI Express x1 network cards, SCSI cards, and other cards that comply with the PCI Express specifications.

### 1.5.5 PCI Express x16 slot

This motherboard supports PCI Express x16 network cards, SCSI cards, and other cards that comply with the PCI Express specifications.

#### IRQ assignments for this motherboard

	A	B	C	D	E	F	G	H
PCIEx16_1	-	-	shared	-	-	-	-	-
PCIEx16_2	shared	-	-	-	-	-	-	-
PCIEx1_1	shared	-	-	-	-	-	-	-
PCI 1	-	-	-	-	shared	-	-	-
Realtek 8111G (LAN)	-	shared	-	-	-	-	-	-
On Chip SATA	-	-	-	shared	-	-	-	-
On Chip USB OHCI 1/2/3/4	-	-	shared	-	-	-	-	-
On Chip USB EHCI 1/2/3	-	shared	-	-	-	-	-	-
On Chip USB XHCI 1	-	-	shared	-	-	-	-	-
On Chip USB XHCI 2	-	shared	-	-	-	-	-	-
HD Audio	shared	-	-	-	-	-	-	-

## 1.6 Jumpers

### 1. Clear RTC RAM (3-pin CLRTC)

This jumper allows you to clear the Real Time Clock (RTC) RAM in CMOS. You can clear the CMOS memory of date, time, and system setup parameters by erasing the CMOS RTC RAM data. The onboard button cell battery powers the RAM data in CMOS, which include system setup information such as system passwords.

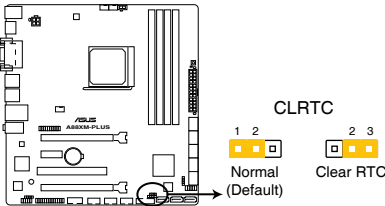

#### A88XM-PLUS Clear RTC RAM

##### To erase the RTC RAM:

1. Turn OFF the computer and unplug the power cord.
2. Move the jumper cap from pins 1-2 (default) to pins 2-3. Keep the cap on pins 2-3 for about 5-10 seconds, then move the cap back to pins 1-2.
3. Plug the power cord and turn ON the computer.
4. Hold down the <Del> key during the boot process and enter BIOS setup to re-enter data.



---

Except when clearing the RTC RAM, never remove the cap on CLRTC jumper default position. Removing the cap will cause system boot failure!

---



- If the steps above do not help, remove the onboard battery and move the jumper again to clear the CMOS RTC RAM data. After clearing the CMOS, reinstall the battery.
  - You do not need to clear the RTC when the system hangs due to overclocking. For system failure due to overclocking, use the CPU Parameter Recall (C.P.R.) feature. Shut down and reboot the system, then the BIOS automatically resets parameter settings to default values.
-

## 2. Chassis intrusion connector (4-1 pin CHASSIS)

This connector is for a chassis-mounted intrusion detection sensor or switch. Connect one end of the chassis intrusion sensor or switch cable to this connector. The chassis intrusion sensor or switch sends a high-level signal to this connector when a chassis component is removed or replaced. The signal is then generated as a chassis intrusion event.

By default, the pins labeled “Intruder” are shorted with a jumper cap. Remove the jumper caps only when you intend to use the chassis intrusion detection feature.

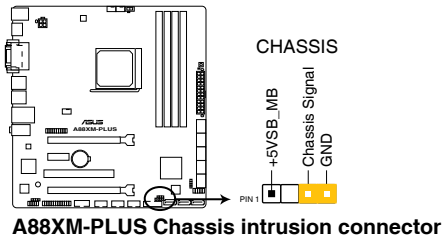

## 1.7 Onboard switches

Onboard switches allow you to fine-tune performance when working on a bare or open-case system. This is ideal for overclockers and gamers who continually change settings to enhance system performance.

### 1. MemOK! switch

Installing DIMMs that are incompatible with the motherboard may cause system boot failure, and the DRAM\_LED near the MemOK! to switch lights continuously. Press and hold the MemOK! switch until the DRAM\_LED starts blinking to begin automatic memory compatibility tuning for successful boot.

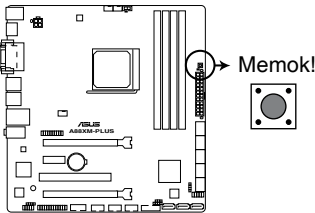

**A88XM-PLUS MemOK! switch**



- Refer to section **1.8 Onboard LEDs** for the exact location of the DRAM\_LED.
- The DRAM\_LED also lights up when the DIMM is not properly installed. Turn off the system and reinstall the DIMM before using the MemOK! function.
- The MemOK! switch does not function under a Windows® OS environment.
- During the tuning process, the system loads and tests failsafe memory settings. It takes about 30 seconds for the system to test one set of failsafe settings. If the test fails, the system reboots and tests the next set of failsafe settings. The blinking speed of the DRAM\_LED increases, indicating different test processes.
- Due to memory tuning requirement, the system automatically reboots when each timing set is tested. If the installed DIMMs still fail to boot after the whole tuning process, the DRAM\_LED lights continuously. Replace the DIMMs with ones recommended in the Memory QVL (Qualified Vendors Lists) in this user manual or on the ASUS website at [www.asus.com](http://www.asus.com).
- If you turn off the computer and replace DIMMs during the tuning process, the system continues memory tuning after turning on the computer. To stop memory tuning, turn off the computer and unplug the power cord for about 5–10 seconds.
- If your system fails to boot due to BIOS overclocking, press the MemOK! switch to boot and load BIOS default settings. A message will appear during POST reminding you that the BIOS has been restored to its default settings.
- We recommend that you download and update to the latest BIOS version from the ASUS website at [www.asus.com](http://www.asus.com) after using the MemOK! function.



## 2. GPU Boost switch

This switch allows you to enable or disable the GPU Boost function.

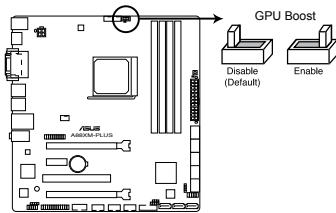

A88XM-PLUS GPU Boost switch

## 1.8 Onboard LEDs

### 1. DRAM LED

DRAM LED checks the DRAM in sequence during motherboard booting process. If an error is found, the LED next to the error device will continue lighting up until the problem is solved.

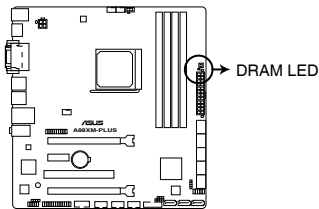

A88XM-PLUS DRAM LED

### 2. GPU Boost LED

The GPU Boost LED lights up when the GPU Boost switch is turned on.

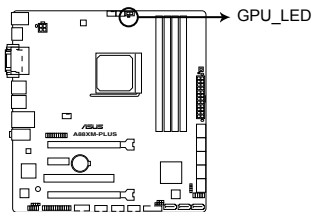

A88XM-PLUS GPU Boost LED

# 1.9 Connectors

## 1.9.1 Rear panel connectors

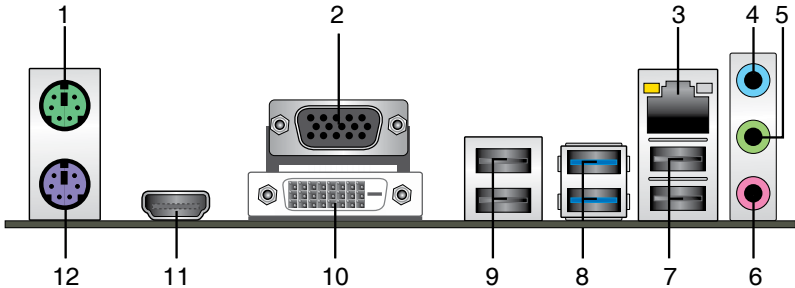

1. **PS/2 mouse port.** This port is for a PS/2 mouse.
2. **Video Graphics Adapter (VGA) port.** This 15-pin port is for a VGA monitor or other VGA-compatible devices.
3. **LAN (RJ-45) port.** This port allows Gigabit connection to a Local Area Network (LAN) through a network hub.

### LAN port LED indications

Activity/Link LED		Speed LED	
Status	Description	Status	Description
OFF	No link	OFF	10Mbps connection
ORANGE	Linked	ORANGE	100Mbps connection
BLINKING	Data activity	GREEN	1Gbps connection

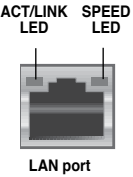

4. **Line In port (light blue).** This port connects to a tape, CD, DVD player, or other audio source.
5. **Line Out port (lime).** This port connects to a headphone or a speaker. In the 4.1, 5.1, and 7.1-channel configurations, the function of this port becomes Front Speaker Out.
6. **Microphone port (pink).** This port connects to a microphone.



Refer to the audio configuration table on the next page for the function of the audio ports in 2.1, 4.1, 5.1 or 7.1-channel configuration.

## Audio 2.1, 4.1, 5.1 or 7.1-channel configuration

Port	Headset 2.1-channel	4.1-channel	5.1-channel	7.1-channel
Light Blue (Rear panel)	Line In	Rear Speaker Out	Rear Speaker Out	Rear Speaker Out
Lime (Rear panel)	Line Out	Front Speaker Out	Front Speaker Out	Front Speaker Out
Pink (Rear panel)	Mic In	Mic In	Bass/Center	Bass/Center
Lime (Front panel)	—	—	—	Side Speaker Out



### To configure an 8-channel audio output:

Use a chassis with HD audio module in the front panel to support an 8-channel audio output.

- 7. USB 2.0 ports 1 and 2.** These two 4-pin Universal Serial Bus (USB) ports are for USB 2.0/1.1 devices.
- 8. USB 3.0 ports 1 and 2.** These two 9-pin Universal Serial Bus (USB) ports are for USB 3.0/2.0 devices.



- DO NOT connect a keyboard / mouse to any USB 3.0 port when installing Windows® operating system.
- Due to USB 3.0 controller limitation, USB 3.0 devices can only be used under Windows® OS environment and after the USB 3.0 driver installation.
- USB 3.0 devices can be used for data storage only.
- We strongly recommend that you connect USB 3.0 devices to USB 3.0 ports for faster and better performance for your USB 3.0 devices.

- 9. USB 2.0 ports 3 and 4.** These two 4-pin Universal Serial Bus (USB) ports are for USB 2.0/1.1 devices.
- 10. DVI-D port.** This port is for any DVI-D compatible device. DVI-D can't be converted to output RGB Signal to CRT and isn't compatible with DVI-I.
- 11. HDMI port.** This port is for a High-Definition Multimedia Interface (HDMI) connector, and is HDCP compliant allowing playback of HD DVD, Blu-ray, and other protected content.
- 12. PS/2 keyboard port.** This port is for a PS/2 keyboard.

## 1.9.2 Internal connectors

### 1. CPU and chassis fan connectors (4-pin CPU\_FAN, and 4-pin CHA\_FAN)

Connect the fan cables to the fan connectors on the motherboard, ensuring that the black wire of each cable matches the ground pin of the connector.

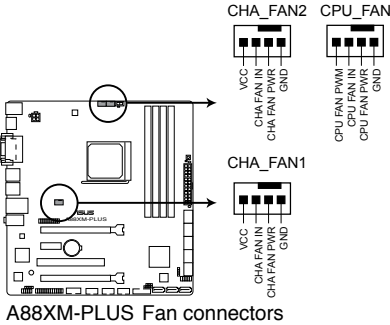

DO NOT forget to connect the fan cables to the fan connectors. Insufficient air flow inside the system may damage the motherboard components. These are not jumpers! DO NOT place jumper caps on the fan connectors.



- The CPU\_FAN connector supports a CPU fan of maximum 2A (24W) fan power.
- Only the 4-pin CPU\_FAN supports the ASUS Fan Xpert2 feature.

## 2. ATX power connectors (24-pin EATXPWR, 4-pin ATX12V)

These connectors are for an ATX power supply. The plugs from the power supply are designed to fit these connectors in only one orientation. Find the proper orientation and push down firmly until the connectors completely fit.

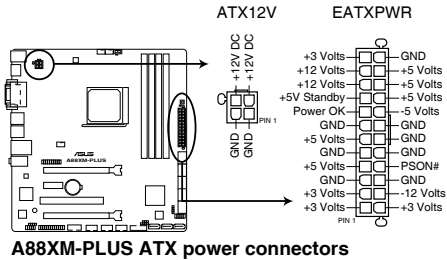

- We recommend that you use an ATX 12V Specification 2.0-compliant power supply unit (PSU) with a minimum of 300W power rating. This PSU type has 24-pin and 4-pin power plugs.
- If you intend to use a PSU with 20-pin and 4-pin power plugs, ensure that the 20-pin power plug can provide at least 15 A on +12 V and that the PSU has a minimum power rating of 300W. The system may become unstable or may not boot up if the power is inadequate.
- DO NOT forget to connect the 4-pin ATX +12V power plug. Otherwise, the system will not boot up.
- We recommend that you use a PSU with higher power output when configuring a system with more power-consuming devices or when you intend to install additional devices. The system may become unstable or may not boot up if the power is inadequate.
- If you are uncertain about the minimum power supply requirement for your system, refer to the Recommended Power Supply Wattage Calculator at <http://support.asus.com/PowerSupplyCalculator/PSCalculator.aspx?SLanguage=en-us> for details.

### 3. Serial ATA 6.0 Gb/s connectors (7-pin SATA6G 1~8)

These connectors are for the Serial ATA 6.0 Gb/s signal cables for Serial ATA hard disk drives and optical disc drives. If you installed Serial ATA hard disk drives, you can create a RAID 0, RAID 1, RAID 10 and JBOD configuration through the onboard controller.

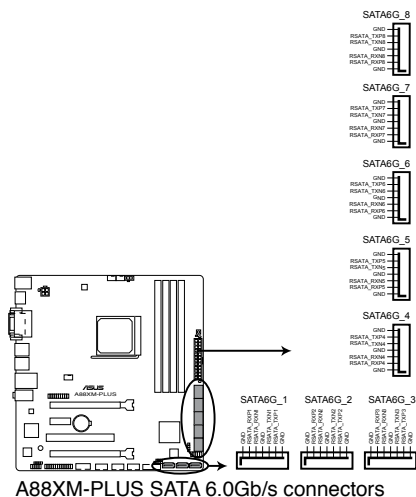

- These connectors are set to AHCI mode by default. If you intend to create a Serial ATA RAID set using these connectors, set the type of the SATA connectors in the BIOS to **[RAID]**. See section **2.6.2 SATA Configuration** for details.
- You must install Windows® XP Service Pack 3 or later version before using Serial ATA hard disk drives. The Serial ATA RAID feature is available only if you are using Windows® XP SP3 or later version.
- When using hot-plug and NCQ, set the type of the SATA connectors in the BIOS to **[AHCI]**. See section **2.6.2 SATA Configuration** for details.

#### 4. System panel connector (10-1 pin PANEL)

This connector supports several chassis-mounted functions.

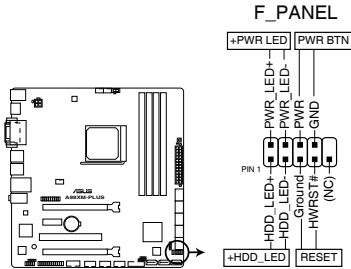

**A88XM-PLUS System panel connector**

- **System power LED (2-pin PLED)**

This 2-pin connector is for the system power LED. Connect the chassis power LED cable to this connector. The system power LED lights up when you turn on the system power, and blinks when the system is in sleep mode.

- **Hard disk drive activity LED (2-pin +HDD\_LED)**

This 2-pin connector is for the HDD Activity LED. Connect the HDD Activity LED cable to this connector. The IDE LED lights up or flashes when data is read from or written to the HDD.

- **ATX power button/soft-off button (2-pin PWRBTN)**

This 2-pin connector is for the system power button.

- **Reset button (2-pin RESET)**

This 2-pin connector is for the chassis-mounted reset button for system reboot without turning off the system power.

#### 5. Speaker connector (4-pin SPEAKER)

The 4-pin connector is for the chassis-mounted system warning speaker. The speaker allows you to hear system beeps and warnings.

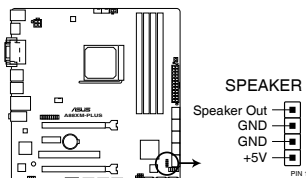

**A88XM-PLUS Speaker Out Connector**

## 6. Digital audio connector (4-1 pin SPDIF\_OUT)

This connector is for an additional Sony/Philips Digital Interface (S/PDIF) port.

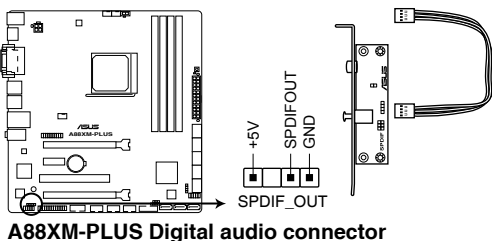

The S/PDIF module is purchased separately.

## 7. Front panel audio connector (10-1 pin AAFP)

This connector is for a chassis-mounted front panel audio I/O module that supports either High Definition Audio or AC'97 audio standard. Connect one end of the front panel audio I/O module cable to this connector.

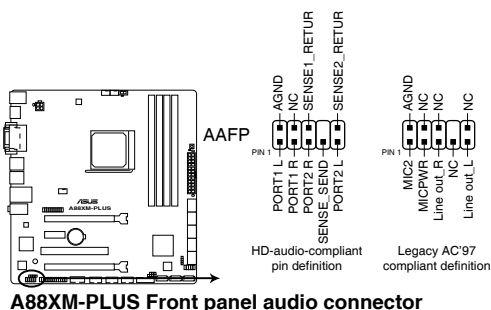

- We recommend that you connect a high-definition front panel audio module to this connector to avail of the motherboard high-definition audio capability.
- If you want to connect a high definition front panel audio module to this connector, set the **Front Panel Type** item in the BIOS to **[HD]**. See section **2.6.4 Onboard Devices Configuration** for details.
- The front panel audio I/O module is purchased separately.



## 8. USB 2.0 connectors (10-1 pin USB910, USB78, and USB56)

These connectors are for USB 2.0 ports. Connect the USB module cable to any of these connectors, then install the module to a slot opening at the back of the system chassis. These USB connectors comply with USB 2.0 specification that supports up to 480Mbps connection speed.

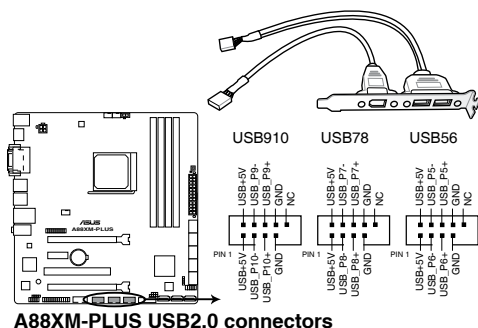

**A88XM-PLUS USB2.0 connectors**



Never connect a 1394 cable to the USB connectors. Doing so will damage the motherboard!



The USB 2.0 module is purchased separately.

## 9. USB 3.0 connector (20-1 pin USB3\_34)

These connectors allow you to connect a USB 3.0 module for additional USB 3.0 front or rear panel ports. With an installed USB 3.0 module, you can enjoy all the benefits of USB 3.0 including faster data transfer speeds of up to 5Gbps, faster charging time for USB-chargable devices, optimized power efficiency and backward compatibility with USB 2.0.

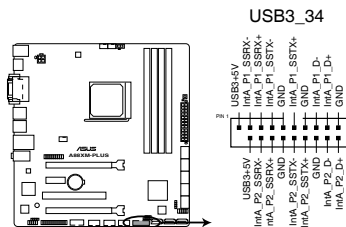

**A88XM-PLUS USB3.0 Front panel connector**



You can connect the ASUS front panel USB 3.0 bracket to this connector to obtain the front panel USB 3.0 solution.

### 10. Serial port connector (10-1 pin COM)

This connector is for a serial (COM) port. Connect the serial port module cable to this connector, then install the module to a slot opening at the back of the system chassis.

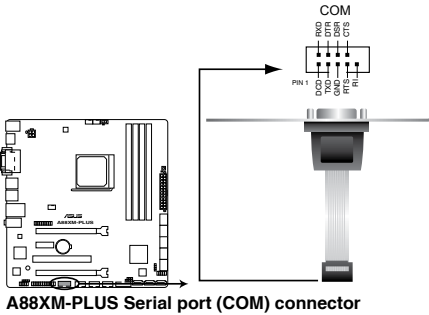

**A88XM-PLUS Serial port (COM) connector**



The COM module is purchased separately.

### 11. TPM connector (20-1 pin TPM)

This connector supports a Trusted Platform Module (TPM) system, which can securely store keys, digital certificates, passwords and data. A TPM system also helps enhance network security, protects digital identities, and ensures platform integrity.

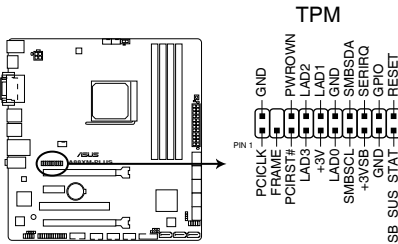

**A88XM-PLUS TPM Connector**

## 12. LPT connector (26-pin LPT)

The LPT (Line Printing Terminal) connector supports devices such as a printer. LPT is standardized as IEEE 1284, which is the parallel port interface on IBM PC-compatible computers.

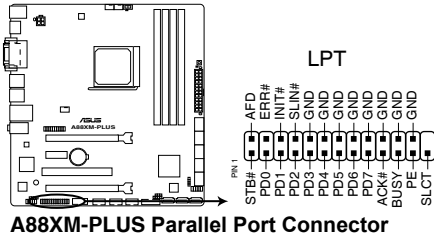

## 1.10 Software support

### 1.10.1 Installing an operating system

This motherboard supports Windows® XP / Windows® 7 / 64-bit Windows® 7 / Windows® 8 / 64-bit Windows® 8 Operating Systems (OS). Always install the latest OS version and corresponding updates to maximize the features of your hardware.



- Motherboard settings and hardware options vary. Refer to your OS documentation for detailed information.
- Ensure that you install Windows® XP Service Pack 3 or later versions / Windows® 7 / 64-bit Windows® 7 / Windows® 8 / 64-bit Windows® 8 before installing the drivers for better compatibility and system stability.

### 1.10.2 Support DVD information

The Support DVD that comes with the motherboard package contains the drivers, software applications, and utilities that you can install to avail all motherboard features.



The contents of the Support DVD are subject to change at any time without notice. Visit the ASUS website at [www.asus.com](http://www.asus.com) for updates.

#### To run the Support DVD

Place the Support DVD into the optical drive. If Autorun is enabled in your computer, the DVD automatically displays the Specials screen. Click Drivers, Utilities, Make Disk, Manual, and Contact tabs to display their respective menus.



The following screen is for reference only.

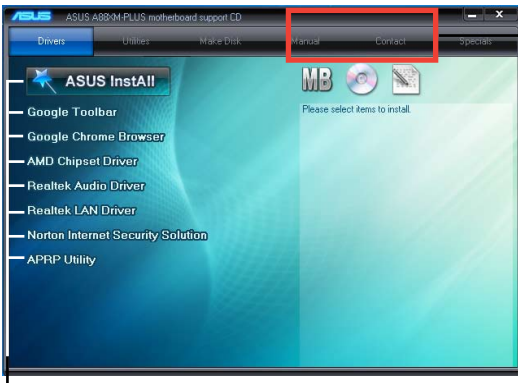

Click an icon to display Support DVD/motherboard information

Click an item to install



If Autorun is NOT enabled on your computer, browse the contents of the Support DVD to locate the file ASSETUP.EXE from the BIN folder. Double-click the ASSETUP.EXE to run the DVD.

# BIOS information

# 2

## 2.1 Managing and updating your BIOS



Save a copy of the original motherboard BIOS file to a USB flash disk in case you need to restore the BIOS in the future. Copy the original motherboard BIOS using the ASUS Update utility.

### 2.1.1 EZ Update

EZ Update is a utility that allows you to automatically update your motherboard's softwares, drivers and the BIOS version easily. With this utility, you can also manually update the saved BIOS and select a boot logo when the system goes into POST.

To launch EZ Update, click **EZ Update** on the AI Suite 3 main menu bar.

Click to automatically update your motherboard's driver, software and firmware

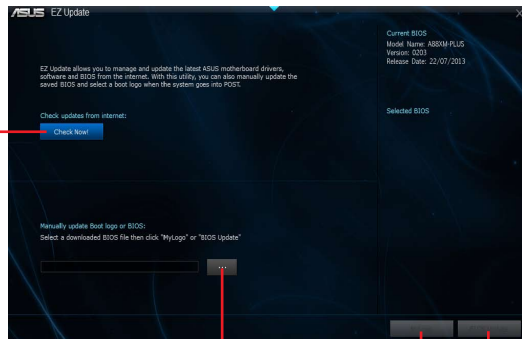

Click to find and select the BIOS from file

Click to select a boot logo

Click to update the BIOS



EZ Update requires an Internet connection either through a network or an ISP (Internet Service Provider).

## 2.1.2 ASUS EZ Flash 2

The ASUS EZ Flash 2 feature allows you to update the BIOS without using an OS-based utility.



Before you start using this utility, download the latest BIOS file from the ASUS website at [www.asus.com](http://www.asus.com).

### To update the BIOS using EZ Flash 2:

1. Insert the USB flash disk that contains the latest BIOS file to the USB port.
2. Enter the **Advanced Mode** of the BIOS setup program. Go to the **Tool** menu to select **ASUS EZ Flash Utility** and press <Enter> to enable it.
3. Press <Tab> to switch to the **Drive** field.
4. Press the Up/Down arrow keys to find the USB flash disk that contains the latest BIOS, and then press <Enter>.
5. Press <Tab> to switch to the **Folder Info** field.
6. Press the Up/Down arrow keys to find the BIOS file, and then press <Enter> to perform the BIOS update process. Reboot the system when the update process is done.



- This function supports USB flash disks formatted using FAT32/16 on a single partition only.
- Ensure to load the BIOS default settings to ensure system compatibility and stability. Select the Load Optimized Defaults item under the Exit menu. .
- DO NOT shut down or reset the system while updating the BIOS to prevent system boot failure!



### 2.1.3 ASUS CrashFree BIOS 3 utility

The ASUS CrashFree BIOS 3 is an auto recovery tool that allows you to restore the BIOS file when it fails or gets corrupted during the updating process. You can restore a corrupted BIOS file using the motherboard support DVD or a USB flash drive that contains the updated BIOS file.



- Before using this utility, rename the BIOS file in the removable device into **A88XMP.CAP**.
- The BIOS file in the support DVD may not be the latest version. Download the latest BIOS file from the ASUS website at [www.asus.com](http://www.asus.com).

### Recovering the BIOS

#### To recover the BIOS:

1. Turn on the system.
2. Insert the support DVD to the optical drive or the USB flash drive that contains the BIOS file to the USB port.
3. The utility automatically checks the devices for the BIOS file. When found, the utility reads the BIOS file and enters ASUS EZ Flash 2 utility automatically.
4. The system requires you to enter BIOS Setup to recover BIOS settings. To ensure system compatibility and stability, we recommend that you press <F5> to load default BIOS values.



DO NOT shut down or reset the system while updating the BIOS! Doing so can cause system boot failure!

### 2.1.4 ASUS BIOS Updater

The ASUS BIOS Updater allows you to update BIOS in a DOS environment. This utility also allows you to copy the current BIOS file that you can use as a backup when the BIOS fails or gets corrupted during the updating process.



The succeeding utility screens are for reference only. The actual utility screen displays may not be same as shown.

#### Before updating BIOS

1. Prepare the motherboard support DVD and a USB flash drive formatted using FAT32/16 on a single partition.
2. Download the latest BIOS file and BIOS Updater from the ASUS website at <http://support.asus.com> and save them on the USB flash drive.



NTFS is not supported under DOS environment. Do not save the BIOS file and BIOS Updater to a hard disk drive or USB flash drive in NTFS format.

3. Turn off the computer and disconnect all SATA hard disk drives (optional).

## Booting the system to a DOS environment

1. Insert the DOS-bootable USB flash drive with the latest BIOS file and BIOS Updater to your computer's USB port.
2. Boot your computer. When the ASUS Logo appears, press <F8> to show the **BIOS Boot Device Select Menu**.

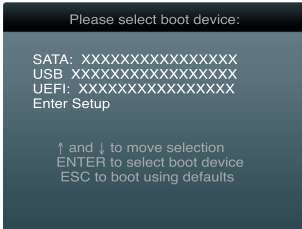

3. Select the USB flash drive as the boot device. The DOS screen appears.



## Updating the BIOS file

To update the BIOS file using BIOS Updater:

1. At the FreeDOS prompt, type **bupdater /pc /g** and press <Enter>.



2. The BIOS Updater screen appears as below.

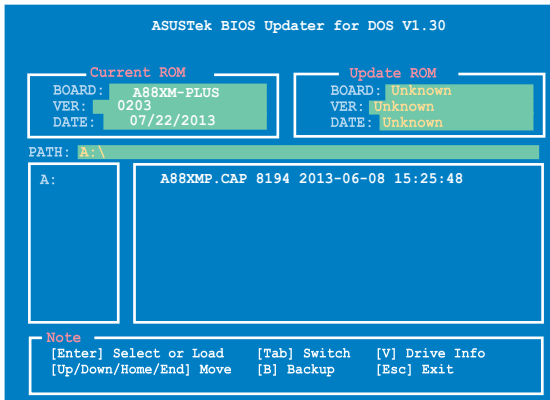



3. Press <Tab> to switch between screen fields and use the <Up/Down/Home/End> keys to select the BIOS file and press <Enter>. BIOS Updater checks the selected BIOS file and prompts you to confirm BIOS update.

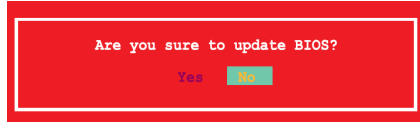

4. Select Yes and press <Enter>. When BIOS update is done, press <ESC> to exit BIOS Updater. Restart your computer.



---

DO NOT shut down or reset the system while updating the BIOS to prevent system boot failure!

---



- For BIOS Updater version 1.30 or later, the utility automatically exits to the DOS prompt after updating BIOS.
  - Ensure to load the BIOS default settings to ensure system compatibility and stability. Select the Load Optimized Defaults item under the Exit menu. Refer to section **2.10 Exit menu** for details.
  - Ensure to connect all SATA hard disk drives after updating the BIOS file if you have disconnected them.
-

## 2.2 BIOS setup program

Use the BIOS Setup program to update the BIOS or configure its parameters. The BIOS screens include navigation keys and brief online help to guide you in using the BIOS Setup program.

### Entering BIOS Setup at startup

To enter BIOS Setup at startup:

- Press <Delete> during the Power-On Self Test (POST). If you do not press <Delete>, POST continues with its routines.

### Entering BIOS Setup after POST

To enter BIOS Setup after POST:

- Press <Ctrl>+<Alt>+<Del> simultaneously.
- Press the reset button on the system chassis.
- Press the power button to turn the system off then back on. Do this option only if you failed to enter BIOS Setup using the first two options.



---

Using the **power button**, **reset button**, or the <Ctrl>+<Alt>+<Del> keys to force reset from a running operating system can cause damage to your data or system. We recommend to always shut down the system properly from the operating system.

---



- The BIOS setup screens shown in this section are for reference purposes only, and may not exactly match what you see on your screen.
  - Ensure that a USB mouse is connected to your motherboard if you want to use the mouse to control the BIOS setup program.
  - The default BIOS settings for this motherboard apply for most conditions to ensure optimum performance. If the system becomes unstable after changing any BIOS settings, load the default settings to ensure system compatibility and stability. Select the **Load Optimized Defaults** item under the Exit Menu. See section 2.10 **Exit Menu**.
  - If the system fails to boot after changing any BIOS setting, try to clear the CMOS and reset the motherboard to the default value. Refer to section 1.6 **Jumpers** on how to erase the RTC RAM.
  - The BIOS setup program does not support the bluetooth devices.
- 

## BIOS menu screen

The BIOS setup program can be used under two modes: **EZ Mode** and **Advanced Mode**. You can change modes from the **Exit** menu or from the **Exit/Advanced Mode** button in the **EZ Mode/Advanced Mode** screen.

### EZ Mode

By default, the EZ Mode screen appears when you enter the BIOS setup program. The EZ Mode provides you an overview of the basic system information, and allows you to select the display language, system performance mode and boot device priority. To access the Advanced Mode, click Exit/Advanced Mode, then select Advanced Mode or press F7 for the advanced BIOS settings.



The default screen for entering the BIOS setup program can be changed. Refer to the **Setup Mode** item in section 2.8 **Boot menu** for details.

- Displays the CPU/motherboard temperature, CPU/5V/3.3V/12V voltage output, CPU/chassis fan speed
- Selects the display language of the BIOS setup program
- Exits the BIOS setup program without saving the changes, saves the changes and resets the system, or enters the Advanced Mode



- Power Saving mode
- Advanced mode functions
- Advanced mode menus
- Boot device priority
- Normal mode
- ASUS Optimal mode
- Selects the boot device priority
- Loads optimized default
- Displays the system properties



- The boot device options vary depending on the devices you installed to the system.
- The **Boot Menu(F8)** button is available only when the boot device is installed to the system.

## Advanced Mode

The Advanced Mode provides advanced options for experienced end-users to configure the BIOS settings. The figure below shows an example of the **Advanced Mode**. Refer to the following sections for the detailed configurations.



To access the EZ Mode, click **Exit**, then select **ASUS EZ Mode**.

Back button   Menu items   Menu bar   Configuration fields   General help

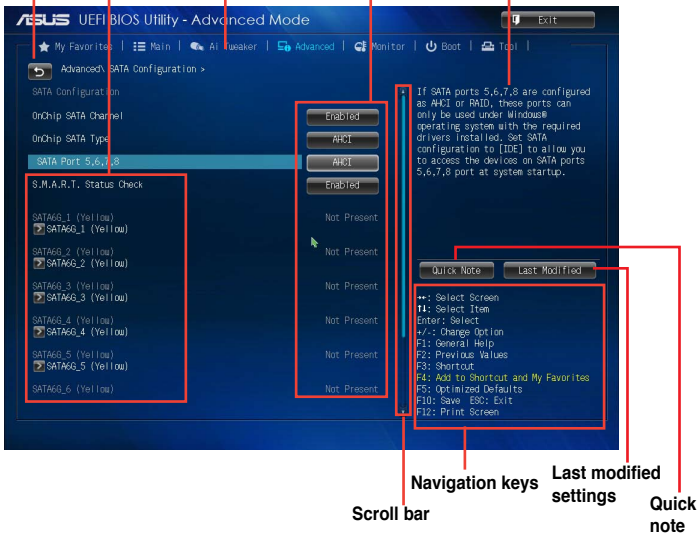

## Menu bar

The menu bar on top of the screen has the following main items:

<b>My Favorites</b>	For saving the frequently-used system settings and configuration
<b>Main</b>	For changing the basic system configuration
<b>Ai Tweaker</b>	For changing the overclocking settings
<b>Advanced</b>	For changing the advanced system settings
<b>Monitor</b>	For displaying the system temperature, power status, and changing the fan settings
<b>Boot</b>	For changing the system boot configuration
<b>Tool</b>	For configuring options for special functions
<b>Exit</b>	For selecting the exit options and loading default settings

## Menu items

The highlighted item on the menu bar displays the specific items for that menu. For example, selecting **Main** shows the Main menu items.

The other items (Ai Tweaker, Advanced, Monitor, Boot, Tool, and Exit) on the menu bar have their respective menu items.

## Back button

This button appears when entering a submenu. Press <Esc> or use the USB mouse to click this button to return to the previous menu screen.

## Submenu items

A greater than sign (>) before each item on any menu screen means that the item has a submenu. To display the submenu, select the item and press <Enter>.

## Pop-up window

Select a menu item and press <Enter> to display a pop-up window with the configuration options for that item.

## Scroll bar

A scroll bar appears on the right side of a menu screen when there are items that do not fit on the screen. Press the Up/Down arrow keys or <Page Up> / <Page Down> keys to display the other items on the screen.

## Navigation keys

At the bottom right corner of the menu screen are the navigation keys for the BIOS setup program. Use the navigation keys to select items in the menu and change the settings.

## General help

At the top right corner of the menu screen is a brief description of the selected item.

## Configuration fields

These fields show the values for the menu items. If an item is user-configurable, you can change the value of the field opposite the item. You cannot select an item that is not user-configurable.

A configurable field is highlighted when selected. To change the value of a field, select it and press <Enter> to display a list of options.

## Quick Note button

This button allows you to enter notes of the activities that you have done in BIOS.

## Last Modified button

This button shows the items that you last modified and saved in BIOS Setup.

## 2.3 My Favorites

MyFavorites is your personal space where you can easily save and access your favorite BIOS items.

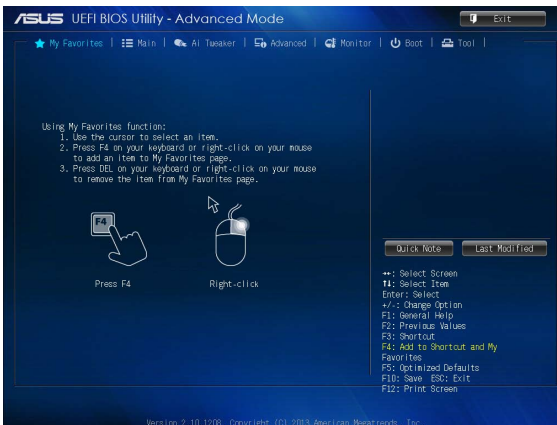

## Adding items to My Favorites

To add frequently-used BIOS items to My Favorites:

1. Use the arrow keys to select an item that you want to add. When using a mouse, hover the pointer to the item.
2. Press <F4> on your keyboard or right-click on your mouse to add the item to My Favorites page.



You cannot add the following items to My Favorites:

- Items with submenu options
- User-configurable items such as language and boot device order
- Configuration items such as Memory SPD Information, system time and date

## 2.4 Main menu

The Main menu screen appears when you enter the Advanced Mode of the BIOS Setup program. The Main menu provides you an overview of the basic system information, and allows you to set the system date, time, language, and security settings.

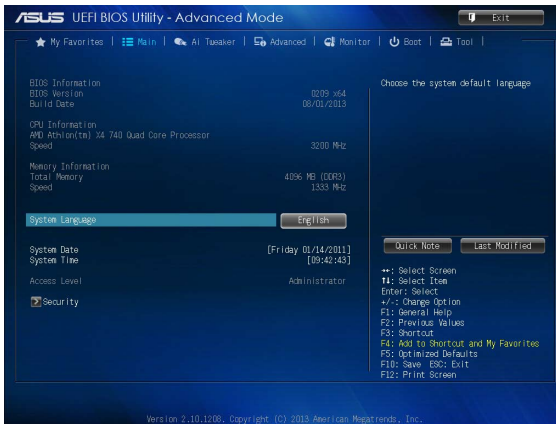

### 2.4.1 System Language [English]

Allows you to choose the BIOS language version from the options. Configuration options: [English] [Français] [Deutsch] [简体中文] [繁體中文] [日本語] [Español] [Русский] [한국어]

### 2.4.2 System Date [Day xx/xx/xxxx]

Allows you to set the system date.

### 2.4.3 System Time [xx:xx:xx]

Allows you to set the system time.

### 2.4.4 Security

The Security menu items allow you to change the system security settings.



- 
- If you have forgotten your BIOS password, erase the CMOS Real Time Clock (RTC) RAM to clear the BIOS password. See section **1.6 Jumpers** for information on how to erase the RTC RAM.
  - The **Administrator** or **User Password** items on top of the screen show the default **Not Installed**. After you set a password, these items show **Installed**.
- 

## Administrator Password

If you have set an administrator password, we recommend that you enter the administrator password for accessing the system. Otherwise, you might be able to see or change only selected fields in the BIOS setup program.

### To set an administrator password:

1. Select the **Administrator Password** item and press <Enter>.
2. From the **Create New Password** box, key in a password, then press <Enter>.
3. Confirm the password when prompted.

### To change an administrator password:

1. Select the **Administrator Password** item and press <Enter>.
2. From the **Enter Current Password** box, key in the current password, then press <Enter>.
3. From the **Create New Password** box, key in a new password, then press <Enter>.
4. Confirm the password when prompted.

To clear the administrator password, follow the same steps as in changing an administrator password, but press <Enter> when prompted to create/confirm the password. After you clear the password, the **Administrator Password** item on top of the screen shows **Not Installed**.

## User Password

If you have set a user password, you must enter the user password for accessing the system. The **User Password** item on top of the screen shows the default **Not Installed**. After you set a password, this item shows **Installed**.

### To set a user password:

1. Select the **User Password** item and press <Enter>.
2. From the **Create New Password** box, key in a password, then press <Enter>.
3. Confirm the password when prompted.

### To change a user password:

1. Select the **User Password** item and press <Enter>.
2. From the **Enter Current Password** box, key in the current password, then press <Enter>.
3. From the **Create New Password** box, key in a new password, then press <Enter>.
4. Confirm the password when prompted.

To clear the user password, follow the same steps as in changing a user password, but press <Enter> when prompted to create/confirm the password. After you clear the password, the **User Password** item on top of the screen shows **Not Installed**.

## 2.5 Ai Tweaker menu

The Ai Tweaker menu items allow you to configure overclocking-related items.



Be cautious when changing the settings of the Ai Tweaker menu items. Incorrect field values can cause the system to malfunction.



The configuration options for this section vary depending on the CPU and DIMM model you installed on the motherboard.

ASUS UEFI BIOS Utility - Advanced Mode

My Favorites | Main | Ai Tweaker | Advanced | Monitor | Boot | Tool

Target CPU Speed : 3200MHz  
Target DRAM Speed : 1333MHz

AI Overclock Tuner: Auto  
Memory Frequency: Auto  
APU Multiplier: Auto  
NB Frequency: Auto  
EPU Power Saving Mode: Disabled  
GPU Boost: Auto  
OC Tuner  
DRAM Timing Control  
APU Voltage: Offset Mode  
CPU Offset Mode Sign: +  
CPU Offset Voltage: 1.300V, Auto  
VDDNB Offset Mode Sign: +

Select the target CPU frequency, and the relevant parameters will be auto-adjusted.

Quick Note | Last Modified

++: Select Screen  
T1: Select Item  
Enter: Select  
+/-: Change Option  
F1: General Help  
F2: Previous Values  
F3: Shortcut  
F4: Add to Shortcut and My Favorites  
F5: Optimized Defaults  
F10: Save ESC: Exit  
F12: Print Screen

Version 2.10.1208. Copyright (C) 2013 American Megatrends, Inc.

Scroll down to display the following items:

VDDA Voltage: 2.500V, Auto

DIGI+ VRM

CPU Load Line Calibration: Auto  
CPU/NB Load Line Calibration: Auto  
CPU Current Capability: 100%  
CPU/NB Current Capability: 100%  
CPU Power Phase Control: Extreme  
CPU Voltage Frequency: 300  
CPU Power Duty Control: T.Probe

\* Do not remove the thermal module. The thermal conditions should be monitored.

Quick Note | Last Modified

++: Select Screen  
T1: Select Item  
Enter: Select  
+/-: Change Option  
F1: General Help  
F2: Previous Values  
F3: Shortcut  
F4: Add to Shortcut and My Favorites  
F5: Optimized Defaults  
F10: Save ESC: Exit  
F12: Print Screen

Version 2.10.1208. Copyright (C) 2013 American Megatrends, Inc.



### **Target CPU Speed : xxxxMHz**

Displays the current CPU speed.

### **Target DRAM Speed : xxxxMHz**

Displays the current DRAM speed.

## **2.5.1 Ai Overclock Tuner [Auto]**

Allows you to select the CPU overclocking options to achieve the desired CPU internal frequency. Select any of these preset overclocking configuration options:

[Auto] Loads the optimal settings for the system.

[Manual] Allows you to individually set overclocking parameters.

## **APU Frequency [XXX]**

This item appears only when you set the **Ai Overclock Tuner** item to [Manual]. Use the <+> and <-> keys to adjust the value. You can also key in the desired value using the numeric keypad. The values range from 90.0MHz to 300.0MHz.

## **2.5.2 Memory Frequency [Auto]**

Allows you to set the memory operating frequency. Configuration options: [Auto] [DDR3-800MHz] [DDR3-1066MHz] [DDR3-1333MHz] [DDR3-1600MHz] [DDR3-1866MHz] [DDR3-2133MHz] [DDR3-2400MHz]



---

Selecting a very high memory frequency may cause the system to become unstable! If this happens, revert to the default setting.

---

## **2.5.3 APU Multiplier [Auto]**

Allows you to set the multiplier between the CPU Core Clock and the FSB Frequency. Use the <+> and <-> keys to adjust the ratio. The valid value ranges vary according to your CPU model.

## **2.5.4 NB Frequency [Auto]**

Allows you to adjust the NB frequency. Use the <+> and <-> keys to adjust the value. You can also key in the desired value using the numeric keypad.

## **2.5.5 EPU Power Saving Mode [Disabled]**

Allows you to enable or disable the EPU power saving function. Configuration options: [Disabled] [Enabled]

### **EPU Setting [Auto]**

This item appears only when The EPU Power Saving Mode is set to [Enabled] and allows you to set power saving mode. Configuration options: [Auto] [Light Power Saving Mode] [Medium Power Saving Mode] [Max Power Saving Mode]

## 2.5.6 GPU Boost [Auto]

- [Auto] Automatic configuration.
- [Turbo Mode] Set to [Turbo Mode] to achieve better 3D performance.
- [Extreme Mode] Set to [Extreme Mode] for the excellent visual experience.
- [Manual Mode] Set to [Manual Mode] if you want to manually select the desired GPU Engine frequency.

## 2.5.7 OC Tuner

OC Tuner automatically overclocks the frequency and voltage of CPU and DRAM for enhancing the system performance. Configuration options: [OK] [Cancel]

## 2.5.8 DRAM Timing Control

The sub-items in this menu allow you to set the DRAM timing control features. Use the <+> and <-> keys to adjust the value. To restore the default setting, type [auto] using the keyboard and press <Enter>.



---

Changing the values in this menu may cause the system to become unstable! If this happens, revert to the default settings.

---

## 2.5.9 APU Voltage [Offset Mode]

- [Offset Mode] To offset the voltage by a positive or negative value.

### CPU Offset Mode Sign [+]

- [+] To offset the voltage by a positive value.
- [-] To offset the voltage by a negative value.

### CPU Offset Voltage [Auto]

Allows you to set the CPU Offset voltage. The values range from 0.00625V to 0.36875V with a 0.000625V interval.



---

Refer to the CPU documentation before setting the CPU voltage. Setting a high voltage may damage the CPU permanently, and setting a low voltage may make the system unstable.

---

### VDDNB Offset Mode Sign [+]

- [+] To offset the voltage by a positive value.
- [-] To offset the voltage by a negative value.

### VDDNB Offset Voltage [Auto]

Allows you to set the VDDNB Offset voltage. The values range from 0.00625V to 0.42500V with a 0.000625V interval.

## 2.5.10 DRAM Voltage [Auto]

Allows you to set the DRAM voltage. The values range from 1.350V to 1.650V with a 0.150V interval.

### 2.5.11 SB 1.1V Voltage [Auto]

Allows you to set the Southbridge 1.1V voltage. The values range from 1.10V to 1.22V with a 0.04V interval.

### 2.5.12 1.1VSB Voltage [Auto]

Allows you to set the 1.1Vsb voltage. The values range from 1.1000V to 1.4000V with a 0.1V interval.

### 2.5.13 APU1.2V Voltage [Auto]

Allows you to set the APU (Accelerated Processor Unit) 1.2V voltage. The values range from 1.2000V to 1.8000V with a 0.01V interval.

### 2.5.14 VDDA Voltage [Auto]

Allows you to set the VDDA voltage. The values range from 2.5000V to 2.8000V with a 0.1V interval.



- 
- The values of the **APU Voltage**, **DRAM Voltage**, **SB 1.1V Voltage**, **1.1VSB Voltage**, **APU1.2V Voltage**, and **VDDA Voltage** items are labeled in a different color, indicating the risk levels of high voltage settings.
  - The system may need better cooling system to work stably under high voltage settings.
- 

### 2.5.15 DIGI+ VRM

#### CPU Load Line Calibration [Auto]

Load-line Calibration is defined by AMD VRM specifications and affects CPU voltage. The CPU working voltage will decrease proportionally to CPU loading. Higher load-line calibration would get higher voltage and better overclocking performance, but increase the CPU and VRM thermal. This item allows you to adjust the voltage range from the following percentages to boost the system performance: 0% (Regular), 60% (Medium), 80% (High), and 100% (Extreme). Configuration options: [Auto] [Regular] [Medium] [High] [Extreme]



---

The actual performance boost may vary depending on your CPU specification.

---

#### CPU/NB Load Line Calibration [Auto]

Allows you to select the CPU/NB Load-Line Calibration mode. Configuration options: [Auto] [Regular] [High] [Extreme]

#### CPU Current Capability [100%]

This item provides wider total power range for overclocking. A higher value brings a wider total power range and extends the overclocking frequency range simultaneously. Configuration options: [100%] [110%] [120%] [130%]

### CPU/NB Current Capability [100%]

This item provides wider total power range for overclocking. A higher value brings a wider total power range and extends the overclocking frequency range simultaneously. Configuration options: [100%] [110%] [120%] [130%]

### CPU Power Phase Control [Standard]

Phase number is the number of working VRM phase. Increasing phase number under heavy system loading to get more transient and better thermal performance. Reducing phase number under light system loading to increase VRM efficiency.

- [Standard] Proceeds phase control depending on the CPU loading.
- [Optimized] Loads the ASUS optimized phase tuning profile.
- [Extreme] Proceeds the full phase mode.
- [Manual Adjustment] Allows manual adjustment.



---

DO NOT remove the thermal module when switching to Extreme and Manual Adjustment. The thermal conditions should be monitored.

---

### Manual Adjustment [Fast]

This item appears only when you set the previous item to [Manual Adjustment]. Select [Ultra Fast] for a faster response. The reaction time will be longer when [Regular] is selected. Configuration options: [Ultra Fast] [Fast] [Medium] [Regular]

### CPU Voltage Frequency [300]

Switching frequency will affect the VRM transient response and component thermal. Setting a higher frequency gets faster transient response. Use the <+> and <-> keys to adjust the value. The values range from 200k Hz to 350k Hz with a 50k Hz interval.

### CPU Power Duty Control [T.Probe]

- [T.Probe] Maintains the VRM thermal balance.
- [Extreme] Maintains the VRM current balance.



---

Do not remove the thermal module while changing the DIGI+VRM related parameters. The thermal conditions should be monitored.

---

## 2.6 Advanced menu

The Advanced menu items allow you to change the settings for the CPU and other system devices.



Be cautious when changing the settings of the Advanced menu items. Incorrect field values can cause the system to malfunction.

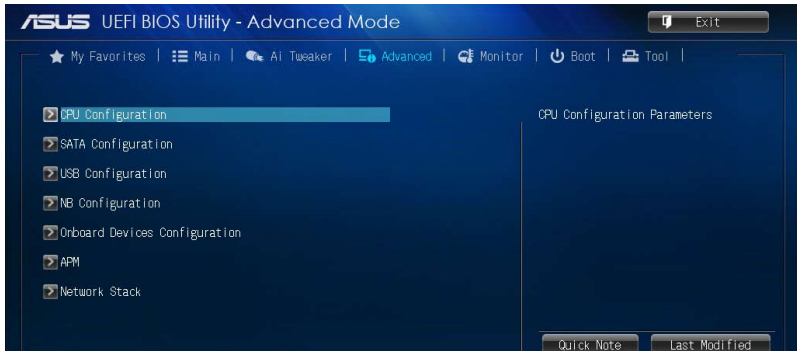

### 2.6.1 CPU Configuration

The items in this menu show the CPU-related information that the BIOS automatically detects.



The items shown in submenu may be different due to the CPU you installed.

#### **AMD PowerNow function [Enabled]**

Enables or disables the AMD PowerNow function. Configuration options: [Enabled] [Disabled]

#### **NX Mode [Enabled]**

Enables or disables the No-execute page protection function. Configuration options: [Enabled] [Disabled]

#### **SVM [Enabled]**

Enables or disables CPU virtualization. Configuration options: [Disabled] [Enabled]

#### **CPB Mode [Auto]**

Disables the CPB (Core Performance Boost) mode or set it to [Auto] for automatic configuration. Configuration options: [Disabled] [Auto]

#### **C6 Mode [Enabled]**

Enables or disables C6 mode. Configuration options: [Enabled] [Disabled]

#### **IOMMU [Disabled]**

Set this item to [Enabled] to show IOMMU Mode. Configuration options: [Enabled] [Disabled]

### **Bank Interleaving [Enabled]**

Enables or disables the bank memory interleaving. Configuration options: [Enabled] [Disabled]

### **Channel Interleaving [Enabled]**

Enables or disables the channel memory interleaving. Configuration options: [Enabled] [Disabled]

### **Core Leveling Mode [Automatic mode]**

Allows you to change the number of working Compute Unit on the system. Configuration options: [Automatic mode] [One core per processor] [One Compute Unit] [One core per Compute Unit]

## **2.6.2 SATA Configuration**

While entering Setup, the BIOS automatically detects the presence of SATA devices. The SATA Port items show **Not Present** if no SATA device is installed to the corresponding SATA port.

### **OnChip SATA Channel [Enabled]**

Enables or disables onboard channel SATA port. Configuration options: [Disabled] [Enabled]

### **OnChip SATA Type [AHCI]**

Allows you to set the SATA configuration.

- [IDE] Set to [IDE] when you want to use the Serial ATA hard disk drives as Parallel ATA physical storage devices.
- [RAID] Set to [RAID] when you want to create a RAID configuration from the SATA hard disk drives.
- [AHCI] Set to [AHCI] when you want the SATA hard disk drives to use the AHCI (Advanced Host Controller Interface). The AHCI allows the onboard storage driver to enable advanced Serial ATA features that increases storage performance on random workloads by allowing the drive to internally optimize the order of commands.

#### **SATA Port 5,6,7,8 [AHCI]**

This item only appears when **OnChip SATA Type** is set to [AHCI]. If SATA ports 5, 6, 7 and 8 are configured as [AHCI], the ports can only be used under Windows® OS with the requested drivers installed. Set to [IDE] instead of [AHCI] to access devices on SATA ports 5, 6 before entering OS. Configuration options: [AHCI] [IDE]

#### **SATA Port 5,6,7,8 [RAID]**

This item only appears when **OnChip SATA Type** is set to [RAID]. If SATA ports 5, 6, 7 and 8 are configured as [RAID], the ports can only be used under Windows® OS with the requested drivers installed. Set to [IDE] instead of [RAID] to access devices on SATA ports 5, 6 before entering OS. Configuration options: [RAID] [IDE]

### **S.M.A.R.T. Status Check [Enabled]**

S.M.A.R.T. (Self-Monitoring, Analysis and Reporting Technology) is a monitor system. When read/write of your hard disk errors occur, this feature allows the hard disk to report warning messages during the POST. Configuration options: [Enabled] [Disabled]

## **2.6.3 USB Configuration**

The items in this menu allow you to change the USB-related features.



---

The **USB Devices** item shows the auto-detected values. If no USB device is detected, the item shows None.

---

### **USB Device Enable [Enabled]**

Allows you to enable or disable all USB ports. Configuration options: [Disabled] [Enabled]

### **Legacy USB Support [Enabled]**

[Enabled] Enables the support for USB devices on legacy operating systems (OS).

[Disabled] The USB devices can be used only for the BIOS setup program.

[Auto] Allows the system to detect the presence of USB devices at startup. If detected, the USB controller legacy mode is enabled. If no USB device is detected, the legacy USB support is disabled.

### **EHCI Hand-off [Disabled]**

[Enabled] Enables the support for operating systems without an EHCI hand-off feature.

[Disabled] Disables the function.

### **USB Single Port Control**

Allows you to enable/disable individual USB ports.

## 2.6.4 NB Configuration

### **IGFX Multi-Monitor [Disabled]**

Enables or disables the Internal Graphics Device Multi-Monitor support for add-on VGA devices. And the memory size of Internal Graphics Device will keep memory reserved.  
Configuration options: [Disabled] [Enabled]



---

The **IGFX Multi-Monitor** item must be enabled before using AMD® Dual Graphics technology.

---

### **Primary Video Device [PCIe / PCI Video]**

Selects the primary display device. Configuration options: [IGFX Video] [PCIe / PCI Video]

### **Integrated Graphics [Auto]**

Enables the integrated graphics controller. Configuration options: [Auto] [Force]

### **UMA Frame Buffer Size [Auto]**

Configuration options: [Auto] [32M] [64M] [128M] [256M] [512M] [1G] [2G]



## 2.6.5 Onboard Devices Configuration

### HD Audio Device [Enabled]

- [Enabled] Enables the High Definition Audio Controller.  
[Disabled] Disables the controller.



---

The following two items appear only when you set the **HD Audio Device** item to [Enabled].

---

### Front Panel Type [HD]

Allows you to set the front panel audio connector (AAFP) mode to legacy AC'97 or high-definition audio depending on the audio standard that the front panel audio module supports.

- [HD] Sets the front panel audio connector (AAFP) mode to high definition audio.  
[AC97] Sets the front panel audio connector (AAFP) mode to legacy AC'97.

### SPDIF Out Type [SPDIF]

- [SPDIF] Sets to [SPDIF] for SPDIF audio output.  
[HDMI] Sets to [HDMI] for HDMI audio output.

### Realtek LAN Controller [Enabled]

- [Enabled] Enables the Realtek LAN controller.  
[Disabled] Disables the controller.

### Realtek PXE OPROM [Disabled]

This item appears only when you set the **Realtek LAN Controller** item to [Enabled] and allows you to enable or disable the Rom of the Realtek LAN controller. Configuration options: [Enabled] [Disabled]

### Serial Port Configuration

The sub-items in this menu allow you to set the serial port configuration.

#### Serial Port [Enabled]

Allows you to enable or disable the serial port (COM). Configuration options: [Enabled] [Disabled]

#### Change Settings [IO=3F8h; IRQ=4]

This item appears only when you set the **Serial Port** to [Enabled] and allows you to select the Serial Port base address. Configuration options: [IO=3F8h; IRQ=4] [IO=2F8h; IRQ=3] [IO=3E8h; IRQ=4] [IO=2E8h; IRQ=3]

## Parallel Port Configuration

The sub-items in this menu allow you to set the parallel port configuration.

### Parallel Port [Enabled]

Allows you to enable or disable the parallel port (LPT/LPTE).

Configuration options: [Enabled] [Disabled]



---

The following items appear only when you set the **Parallel Port Configuration** item to [Enabled].

---

### Change Settings [Auto]

Allows you to select an optimal setting for Super I/O devices. Configuration options: [Auto] [IO=378h; IRQ=5,] [IO=378h; IRQ=5,6,7,9,10,11,12,] [IO=278h; IRQ=5,6,7,9,10,11,12,] [IO=3BCh; IRQ=5,6,7,9,10,11,12,]

### Device Mode [STD Printer Mode]

Allows you to select the Printer Port mode. Configuration options: [STD Printer Mode] [SPP Mode] [EPP-1.9 and SPP Mode] [EPP-1.7 and SPP Mode] [ECP Mode] [ECP and EPP 1.9 Mode] [ECP and EPP 1.7 Mode]

## 2.6.6 APM

### Deep S4 [Disabled]

When enabled, the system in S4 state will further reduce power usage and will power off the USB and PS/2 devices. The system in deep S4 state can be woken up via the power button, devices in LAN, or other ways except via the USB and PS/2 devices. Configuration options: [Disabled] [Enabled]

### Restore AC Power Loss [Power Off]

[Power On] The system goes into on state after an AC power loss.

[Power Off] The system goes into off state after an AC power loss.

[Last State] The system goes into either off or on state, whatever the system state was before the AC power loss.

### Power On By PS/2 Keyboard [Disabled]

[Disabled] Disables the Power On by a PS/2 keyboard.

[Space Bar] Sets the Space Bar on the PS/2 keyboard to turn on the system.

[Ctrl-Esc] Sets the Ctrl+Esc key on the PS/2 keyboard to turn on the system.

[Power Key] Sets Power key on the PS/2 keyboard to turn on the system. This feature requires an ATX power supply that provides at least 1A on the +5VSB lead.

### Power On By PS/2 Mouse [Disabled]

[Disabled] Disables the Power On by a PS/2 mouse.

[Enabled] Enables the Power On by a PS/2 mouse. This feature requires an ATX power supply that provides at least 1A on the +5VSB lead.

### **WOL (include AC Power Loss) [Disabled]**

[Disabled] Disables Wake On LAN after a power failure (G3 state).

[Enabled] Enables Wake On LAN after a power failure (G3 state).

### **Power On By PME [Disabled]**

[Disabled] Disables the PME to wake up by PCI/PCIE devices.

[Enabled] Allows you to turn on the system through a PCI/PCIE LAN or modem card. This feature requires an ATX power supply that provides at least 1A on the +5VSB lead.

### **Power On By Ring [Disabled]**

[Disabled] Disables Ring to generate a wake event.

[Enabled] Enables Ring to generate a wake event.

### **Power On By RTC [Disabled]**

[Disabled] Disables RTC to generate a wake event.

[Enabled] When set to [Enabled], the items **RTC Alarm Date (Days)** and **Hour/Minute/Second** will become user-configurable with set values.

### **RTC Alarm Date (Days)**

This item appears only when you set the previous item to [Enabled] and allows you to select RTC alarm time (days). When you set the time to zero, the RTC alarms everyday. Use <+> and <-> keys to adjust the time.

### **- Hour / - Minute / - Second**

Allows you to set the RTC alarm time. Use <+> and <-> keys to adjust the time.

## **2.6.7 Network Stack**

### **Network Stack [Disabled]**

This item allows user to disable or enable the UEFI network stack. Configuration options:

[Disabled] [Enabled]



---

The following two items appear only when you set the previous item to [Enabled].

---

### **Ipv4 PXE Support [Enabled]**

This item allows user to disable or enable the Ipv4 PXE Boot support. Configuration options:

[Disabled] [Enable]

### **Ipv6 PXE Support [Enabled]**

This item allows user to disable or enable the Ipv6 PXE Boot support. Configuration options:

[Disabled] [Enabled]

## 2.7 Monitor menu

The Monitor menu displays the system temperature/power status, and allows you to change the fan settings.

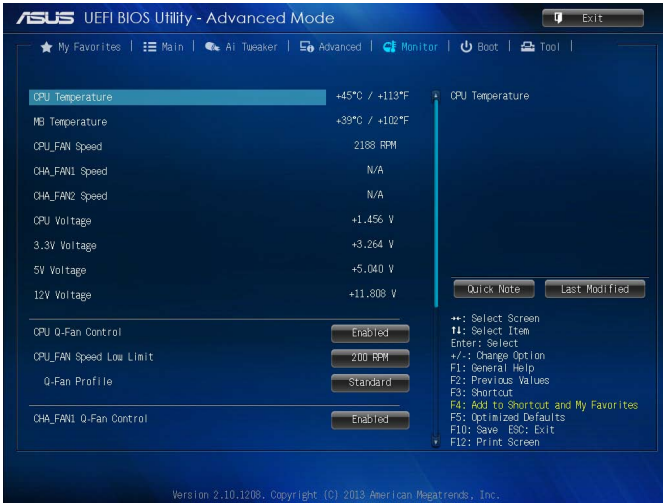

Scroll down to display the following items:



### 2.7.1 CPU Temperature / MB Temperature [xxx°C/xxx°F]

The onboard hardware monitor automatically detects and displays the CPU and motherboard temperatures. Select **Ignore** if you do not wish to display the detected temperatures.

### 2.7.2 CPU / Chassis Fan Speed [xxxx RPM] or [Ignore] / [N/A]

The onboard hardware monitor automatically detects and displays the CPU / chassis fan speeds in rotations per minute (RPM). If the fan is not connected to the motherboard, the field shows **N/A**. Select **Ignore** if you do not wish to display the detected speed.

### 2.7.3 CPU Voltage, 3.3V Voltage, 5V Voltage, 12V Voltage

The onboard hardware monitor automatically detects the voltage output through the onboard voltage regulators. Select **Ignore** if you do not want to detect this item.

### 2.7.4 CPU Q-Fan Control [Enabled]

[Disabled] Disables the CPU Q-Fan control feature.

[Enabled] Enables the CPU Q-Fan control feature.

#### CPU Fan Speed Low Limit [200 RPM]

This item appears only when you enable the **CPU Q-Fan Control** feature and allows you to disable or set the CPU fan warning speed. Configuration options: [Ignore] [100 RPM] [200 RPM] [300 RPM] [400 RPM] [500 RPM]

#### CPU Fan Profile [Standard]

This item appears only when you enable the **CPU Q-Fan Control** feature and allows you to set the appropriate performance level of the CPU fan.

[Standard] Sets to [Standard] to make the CPU fan automatically adjust depending on the CPU temperature.

[Silent] Sets to [Silent] to minimize the fan speed for quiet CPU fan operation.

[Turbo] Sets to [Turbo] to achieve maximum CPU fan speed.

[Manual] Sets to [Manual] to assign detailed fan speed control parameters.



---

The following four items appear only when you set **Q-Fan Profile** to [Manual].

---

#### CPU Q-Fan Upper Temperature [70]

Use the <+> and <-> keys to adjust the upper limit of the CPU temperature. The values range from 20°C to 75°C.

#### CPU Q-Fan Max. Duty Cycle(%) [100]

Use the <+> and <-> keys to adjust the maximum CPU fan duty cycle. The values range from 0% to 100%. When the CPU temperature reaches the upper limit, the CPU fan will operate at the maximum duty cycle.

### **CPU Q-Fan Lower Temperature [20]**

Use the <+> and <-> keys to adjust the lower limit of the CPU temperature. The values range from 20°C to 75°C.

### **CPU Q-Fan Min. Duty Cycle(%) [20]**

Use the <+> and <-> keys to adjust the minimum CPU fan duty cycle. The values range from 0% to 100%. When the CPU temperature is under the lower limit, the CPU fan will operate at the minimum duty cycle.

## **2.7.5 CHA\_FAN1~2 Q-Fan Control [Enabled]**

[Disabled] Disables the Chassis1 Q-Fan control feature.

[Enabled] Enables the Chassis1 Q-Fan control feature.

### **CHA\_FAN Fan Speed Low Limit [600 RPM]**

This item appears only when you enable the Chassis1 Q-Fan Control feature and allows you to disable or set the chassis1 fan warning speed.

Configuration options: [Ignore] [200RPM] [300 RPM] [400 RPM] [500 RPM] [600 RPM]

### **Q-Fan Profile [Standard]**

This item appears only when you enable the Chassis1 Q-Fan Control feature and allows you to set the appropriate performance level of the chassis fan.

[Standard] Sets to [Standard] to make the chassis fan automatically adjust depending on the chassis temperature.

[Silent] Sets to [Silent] to minimize the fan speed for quiet chassis fan operation.

[Turbo] Sets to [Turbo] to achieve maximum chassis fan speed.

[Manual] Sets to [Manual] to assign detailed fan speed control parameters.



---

The following four items appear only when you set Q-Fan Profile to [Manual].

---

### **Q-Fan Upper Temperature [70]**

Use the <+> and <-> keys to adjust the upper limit of the chassis temperature. The values range from 40°C to 75°C.

### **Q-Fan Max. Duty Cycle(%) [100]**

Use the <+> and <-> keys to adjust the maximum chassis fan duty cycle. The values range from 60% to 100%. When the chassis temperature reaches the upper limit, the chassis fan will operate at the maximum duty cycle.

### **Q-Fan Lower Temperature [40]**

Displays the lower limit of the chassis temperature.

### **Q-Fan Min. Duty Cycle(%) [60]**

Use the <+> and <-> keys to adjust the minimum chassis fan duty cycle. The values range from 60% to 100%. When the chassis temperature is under 40°C, the chassis fan will operate at the minimum duty cycle.

## 2.7.6 Anti Surge Support [Auto]

This item allows you to enable or disable the Anti Surge function. Configuration options: [Auto] [Disabled] [Enabled]

## 2.8 Boot menu

The Boot menu items allow you to change the system boot options.

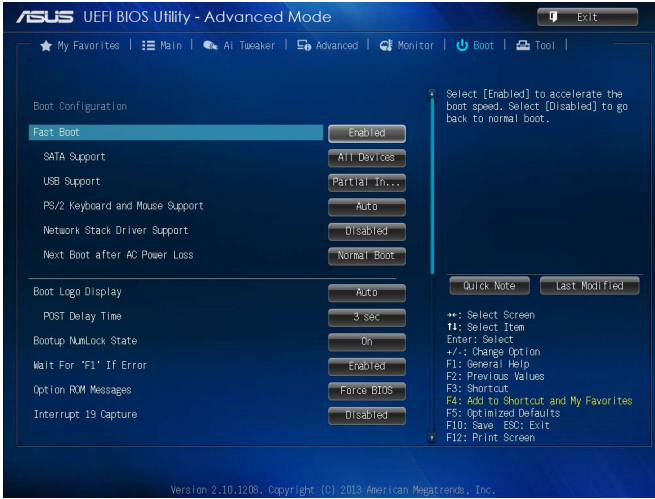

Scroll down to display the following items:



## 2.8.1 Fast Boot [Enabled]

[Enabled] Select to accelerate the boot speed.

[Disabled] Select to go back to normal boot.



---

The following four items appear when you set **Fast Boot** to [Enabled].

---

### SATA Support [All Devices]

[All Devices] All devices connected to SATA ports will be available during POST. This process will extend the POST time.

[Hard Drive Only] Only hard drives connected to SATA ports will be detected during POST. Any hardware change will disable fast boot.

[Boot Drive Only] Only boot drive connected to SATA ports will be detected during POST. Any hardware change will disable fast boot.

### USB Support [Partial Initialization]

[Disabled] All USB devices will not be available until OS boot up for a fastest POST time.

[Full Initialization] All USB devices will be available during POST. This process will extend the POST time.

[Partial Initialization] For a faster POST time, only the USB ports with keyboard and mouse connections will be detected.

### PS/2 Keyboard and Mouse Support [Auto]

Select any of these settings when PS/2 keyboard and mouse are installed. These settings only apply when Fast Boot is enabled.

[Auto] For a faster POST time, PS/2 devices will only be available when the system boots up or rebooted when the PS/2 devices have not been reconnected or changed. If you disconnect or change PS/2 devices before restarting the system, PS/2 devices will not be available and BIOS setup program will not be accessible via PS/2 devices.

[Full Initialization] For full system control, PS/2 devices will be available during POST at any circumstances. This process will extend POST time.

[Disabled] For the fastest POST time, all PS/2 devices will not be available until your computer enters the operating system.

### Network Stack Driver Support [Disabled]

[Disabled] Select to skip the network stack driver from loading during POST.

[Enabled] Select to load the network stack driver during POST.

### Next Boot after AC Power Loss [Normal Boot]

[Normal Boot] Returns to normal boot on the next boot after AC power loss.

[Fast Boot] Accelerates the boot speed on the next boot after AC power loss.



## 2.8.2 Boot Logo Display [Enabled]

### Boot Logo Display [Auto]

- [Auto] Adjust automatically for Windows® requirement.
- [Full Screen] Maximize the boot logo size.
- [Disabled] Hide the logo during POST.

### POST Delay Time [3 sec]

This item appears only when you set Boot Logo Display to [Enabled]. This item allows you to select the desired additional POST waiting time to easily enter the BIOS setup. You can only execute the POST delay time during Normal Boot. The values range from 0 to 10 seconds.



---

This feature will only work under normal boot.

---

### Post Report [5 sec]

This item appears only when you set Boot Logo Display to [Disabled]. This item allows you to select a desired post report waiting time. The values range from 1 to 10 seconds.

## 2.8.3 Bootup NumLock State [On]

- [On] Sets the power-on state of the NumLock to [On].
- [Off] Sets the power-on state of the NumLock to [Off].

## 2.8.4 Wait for 'F1' If Error [Enabled]

When this item is set to [Enabled], the system waits for the F1 key to be pressed when error occurs. Configuration options: [Disabled] [Enabled]

## 2.8.5 Option ROM Messages [Force BIOS]

- [Force BIOS] The third-party ROM messages will be forced to display during the boot sequence.
- [Keep Current] The third-party ROM messages will be displayed only if the third-party manufacturer had set the add-on device to do so.

## 2.8.6 Interrupt 19 Capture [Disabled]

- [Enabled] Allows the option ROMs to trap Interrupt 19.
- [Disabled] Disables this function.

## 2.8.7 Setup Mode [EZ Mode]

- [Advanced Mode] Sets Advanced Mode as the default screen for entering the BIOS setup program.
- [EZ Mode] Sets EZ Mode as the default screen for entering the BIOS setup program.

## 2.8.8 CSM (Compatibility Support Module)

Allows you to configure the CSM (Compatibility Support Module) items to fully support the various VGA, bootable devices and add-on devices for better compatibility.

### Launch CSM [Enabled]

- [Auto] The system automatically detects the bootable devices and the add-on devices.
- [Enabled] For better compatibility, enable the CSM to fully support the non-UEFI driver add-on devices or the Windows® UEFI mode.
- [Disabled] Disable the CSM to fully support the Windows® Security Update and Security Boot.



---

The following four items appear when you set Launch CSM to [Enabled].

---

### Boot Device Control [UEFI and Legacy OpROM]

Allows you to select the type of devices that you want to boot up. Configuration options: [UEFI and Legacy OpROM] [Legacy OpROM only] [UEFI only]

### Boot from Network Devices [Legacy OpROM first]

Allows you to select the type of network devices that you want to launch. Configuration options: [Legacy OpROM first] [UEFI driver first] [Ignore]

### Boot from Storage Devices [Legacy OpROM first]

Allows you to select the type of storage devices that you want to launch. Configuration options: [Both, Legacy OpROM first] [Both, UEFI first] [Legacy OpROM first] [UEFI driver first] [Ignore]

### Boot from PCIe/PCI Expansion Devices [Legacy OpROM first]

Allows you to select the type of PCIe/PCI expansion devices that you want to launch. Configuration options: [Legacy OpROM first] [UEFI driver first]

## 2.8.9 Secure Boot

Allows you to configure the Windows® Secure Boot settings and manage its keys to protect the system from unauthorized access and malwares during POST.

## OS Type [Windows UEFI mode]

Allows you to select your installed operating system.

[Windows UEFI mode]	Executes the Microsoft® Secure Boot check. Only select this option when booting on Windows® UEFI mode or other Microsoft® Secure Boot compliant OS.
[Other OS]	Get the optimized function when booting on Windows® non-UEFI mode, Windows® Vista/XP, or other Microsoft® Secure Boot non-compliant OS. Only on Windows® UEFI mode that Microsoft® Secure Boot can function properly.

## Secure Boot Mode [Standard]

This item appears only when you set the OS Type to [Windows UEFI]. Configuration option: [Standard] [Custom]



---

The following item appears when **OS Type** is set to [Windows UEFI mode].

---

## Key Management

This item appears only when you set Secure Boot Mode to [Custom]. It allows you to manage the Secure Boot keys.

### Clear Secure Boot keys

This item appears only when you load the default Secure Boot keys. This item allows you to clear all default Secure Boot keys.

### Save Secure Boot keys

This item appears only when you load the default Secure Boot keys. This item allows you to save all default Secure Boot keys.

### PK Management

The Platform Key (PK) locks and secures the firmware from any non-permissible changes. The system verifies the PK before your system enters the OS.

#### **Delete PK**

Allows you to delete the PK from your system. Once the PK is deleted, all the system's Secure Boot keys will not be active. Configuration options: [Yes] [No]

#### **Load PK from File**

Allows you to load the downloaded PK from a USB storage device.



---

The PK file must be formatted as a UEFI variable structure with time-based authenticated variable.

---

## KEK Management

The KEK (Key-exchange Key or Key Enrollment Key) manages the Signature database (db) and Revoked Signature database (dbx).



---

Key-exchange Key (KEK) refers to Microsoft® Secure Boot Key-Enrollment Key (KEK).

---

### **Delete the KEK**

Allows you to delete the KEK from your system. Configuration options: [Yes] [No]

### **Load KEK from File**

Allows you to load the downloaded KEK from a USB storage device.

### **Append KEK from file**

Allows you to load the additional KEK from a storage device for an additional db and dbx loaded management.



---

The KEK file must be formatted as a UEFI variable structure with time-based authenticated variable.

---

## DB Management

The db (Authorized Signature database) lists the signers or images of UEFI applications, operating system loaders, and UEFI drivers that you can load on the single computer.

### **Delete the db**

Allows you to delete the db file from your system. Configuration options: [Yes] [No]

### **Load db from File**

Allows you to load the downloaded db from a USB storage device.

### **Append db from file**

Allows you to load the additional db from a storage device so that more images can be loaded securely.



---

The DB file must be formatted as a UEFI variable structure with time-based authenticated variable.

---

## DBX Management

The dbx (Revoked Signature database) lists the forbidden images of db items that are no longer trusted and cannot be loaded.

### **Delete the DBX**

Allows you to delete the DBX file from your system. Configuration options: [Yes] [No]

### **Load DBX from File**

Allows you to load the downloaded DBX from a USB storage device.

### ***Append DBX from file***

Allows you to load the additional DBX from a storage device so that more db's images cannot be loaded.



---

The DBX file must be formatted as a UEFI variable structure with time-based authenticated variable.

---

## **2.8.10 Boot Option Priorities**

These items specify the boot device priority sequence from the available devices. The number of device items that appears on the screen depends on the number of devices installed in the system.



- 
- To select the boot device during system startup, press <F8> when ASUS Logo appears.
  - To access Windows OS in Safe Mode, press <F8> after POST.
- 

## **2.8.11 Boot Override**

These items displays the available devices. The number of device items that appears on the screen depends on the number of devices installed in the system. Click an item to start booting from the selected device.

## 2.9 Tools menu

The Tools menu items allow you to configure options for special functions. Select an item then press <Enter> to display the submenu.

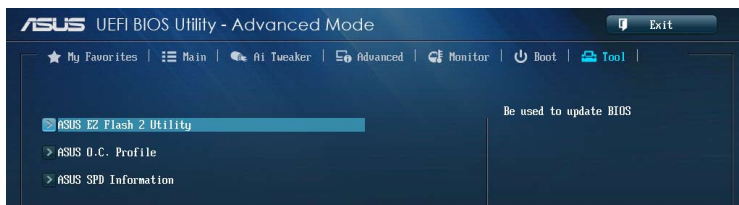

### 2.9.1 ASUS EZ Flash 2 Utility

Allows you to run ASUS EZ Flash 2. Press [Enter] to launch the ASUS EZ Flash 2 screen.



---

For more details, see section 2.1.2 **ASUS EZ Flash 2**.

---

### 2.9.2 ASUS SPD Information

#### DIMM Slot # [DIMM\_A1]

Displays the Serial Presence Detect (SPD) information of the DIMM module installed on the selected slot. Configuration options: [DIMM\_A1] [DIMM\_B1] [DIMM\_A2] [DIMM\_B2]

### 2.9.3 ASUS O.C. Profile

This item allows you to store or load multiple BIOS settings.



---

The **Setup Profile Status** items show **Not Installed** if no profile is created.

---

#### Label

Allows you to input the label of the setup profile.

#### Save to Profile

Allows you to save the current BIOS settings to the BIOS Flash, and create a profile. Key in a profile number from one to eight, press <Enter>, and then select **Yes**.

#### Load from Profile

Allows you to load the previous BIOS settings saved in the BIOS Flash. Key in the profile number that saved your CMOS settings, press <Enter>, and then select **Yes**.



- DO NOT shut down or reset the system while updating the BIOS to prevent the system boot failure!
  - We recommend that you update the BIOS file only coming from the same memory/ CPU configuration and BIOS version.
- 

#### Load/Save Profile from/to USB Drive

Allows you to load/save CMOS profile from/to USB drive.

## 2.10 Exit menu

The Exit menu items allow you to load the optimal default values for the BIOS items, and save or discard your changes to the BIOS items. You can access the **EZ Mode** from the Exit menu.



### Load Optimized Defaults

This option allows you to load the default values for each of the parameters on the Setup menus. When you select this option or if you press <F5>, a confirmation window appears. Select **Yes** to load the default values.

### Save Changes & Reset

Once you are finished making your selections, choose this option from the Exit menu to ensure the values you selected are saved. When you select this option or if you press <F10>, a confirmation window appears. Select **Yes** to save changes and exit.

### Discard Changes & Exit

This option allows you to exit the Setup program without saving your changes. When you select this option or if you press <Esc>, a confirmation window appears. Select **Yes** to discard changes and exit.

### ASUS EZ Mode

This option allows you to enter the EZ Mode screen.

### Launch EFI Shell from filesystem device

This option allows you to attempt to launch the UEFI Shell application (shellx64.efi) from one of the available devices that have a filesystem.





# Appendices

## Notices

### Federal Communications Commission Statement

This device complies with Part 15 of the FCC Rules. Operation is subject to the following two conditions:

- This device may not cause harmful interference.
- This device must accept any interference received including interference that may cause undesired operation.

This equipment has been tested and found to comply with the limits for a Class B digital device, pursuant to Part 15 of the FCC Rules. These limits are designed to provide reasonable protection against harmful interference in a residential installation. This equipment generates, uses and can radiate radio frequency energy and, if not installed and used in accordance with manufacturer's instructions, may cause harmful interference to radio communications. However, there is no guarantee that interference will not occur in a particular installation. If this equipment does cause harmful interference to radio or television reception, which can be determined by turning the equipment off and on, the user is encouraged to try to correct the interference by one or more of the following measures:

- Reorient or relocate the receiving antenna.
- Increase the separation between the equipment and receiver.
- Connect the equipment to an outlet on a circuit different from that to which the receiver is connected.
- Consult the dealer or an experienced radio/TV technician for help.



The use of shielded cables for connection of the monitor to the graphics card is required to assure compliance with FCC regulations. Changes or modifications to this unit not expressly approved by the party responsible for compliance could void the user's authority to operate this equipment.

### IC: Canadian Compliance Statement

Complies with the Canadian ICES-003 Class B specifications. This device complies with RSS 210 of Industry Canada. This Class B device meets all the requirements of the Canadian interference-causing equipment regulations.

This device complies with Industry Canada license exempt RSS standard(s). Operation is subject to the following two conditions: (1) this device may not cause interference, and (2) this device must accept any interference, including interference that may cause undesired operation of the device.

Cet appareil numérique de la Classe B est conforme à la norme NMB-003 du Canada.

Cet appareil numérique de la Classe B respecte toutes les exigences du Règlement sur le matériel brouilleur du Canada.

Cet appareil est conforme aux normes CNR exemptes de licence d'Industrie Canada. Le fonctionnement est soumis aux deux conditions suivantes :

- (1) cet appareil ne doit pas provoquer d'interférences et
- (2) cet appareil doit accepter toute interférence, y compris celles susceptibles de provoquer un fonctionnement non souhaité de l'appareil.

## Canadian Department of Communications Statement

This digital apparatus does not exceed the Class B limits for radio noise emissions from digital apparatus set out in the Radio Interference Regulations of the Canadian Department of Communications.

This class B digital apparatus complies with Canadian ICES-003.

## VCCI: Japan Compliance Statement

### VCCI Class B Statement

情報処理装置等電波障害自主規制について

この装置は、情報処理装置等電波障害自主規制協議会（VCCI）の基準に基づくクラスB情報技術装置です。この装置は家庭環境で使用されることを目的としていますが、この装置がラジオやテレビジョン受信機に近接して使用されると、受信障害を引き起こすことがあります。

取扱説明書に従って正しい取り扱いをして下さい。

## KC: Korea Warning Statement

B급 기기 (가정용 방송통신기자재)

이 기기는 가정용(B급) 전자파적합기기로서 주로 가정에서 사용하는 것을 목적으로 하며, 모든 지역에서 사용할 수 있습니다.

\*당해 무선설비는 전파혼신 가능성이 있으므로 인명안전과 관련된 서비스는 할 수 없습니다.

## REACH

Complying with the REACH (Registration, Evaluation, Authorisation, and Restriction of Chemicals) regulatory framework, we published the chemical substances in our products at ASUS REACH website at <http://csr.asus.com/english/REACH.htm>.



DO NOT throw the motherboard in municipal waste. This product has been designed to enable proper reuse of parts and recycling. This symbol of the crossed out wheeled bin indicates that the product (electrical and electronic equipment) should not be placed in municipal waste. Check local regulations for disposal of electronic products.



DO NOT throw the mercury-containing button cell battery in municipal waste. This symbol of the crossed out wheeled bin indicates that the battery should not be placed in municipal waste.

## ASUS Recycling/Takeback Services

ASUS recycling and takeback programs come from our commitment to the highest standards for protecting our environment. We believe in providing solutions for you to be able to responsibly recycle our products, batteries, other components as well as the packaging materials. Please go to <http://csr.asus.com/english/Takeback.htm> for detailed recycling information in different regions.

## ASUS contact information

### ASUSTeK COMPUTER INC.

Address 15 Li-Te Road, Peitou, Taipei, Taiwan 11259  
Telephone +886-2-2894-3447  
Fax +886-2-2890-7798  
E-mail info@asus.com.tw  
Web site www.asus.com.tw

#### *Technical Support*

Telephone +86-21-38429911  
Online support support.asus.com

### ASUS COMPUTER INTERNATIONAL (America)

Address 800 Corporate Way, Fremont, CA 94539, USA  
Telephone +1-812-282-3777  
Fax +1-510-608-4555  
Web site usa.asus.com

#### *Technical Support*

Telephone +1-812-282-2787  
Support fax +1-812-284-0883  
Online support support.asus.com

### ASUS COMPUTER GmbH (Germany and Austria)

Address Harkort Str. 21-23, D-40880 Ratingen, Germany  
Fax +49-2102-959911  
Web site www.asus.de  
Online contact www.asus.de/sales

#### *Technical Support*

Telephone +49-1805-010923\*  
Support Fax +49-2102-9599-11  
Online support support.asus.com

\* EUR 0.14/minute from a German fixed landline; EUR 0.42/minute from a mobile phone.

<b>Manufacturer:</b>	ASUSTeK Computer Inc.
<b>Address:</b>	4F, No. 150, LI-TE RD., PEITOU, TAIPEI 112, TAIWAN R.O.C.
<b>Authorised representative in Europe:</b>	ASUS Computer GmbH
<b>Address:</b>	HARKORT STR. 21-23, 40880 RATINGEN, GERMANY

# DECLARATION OF CONFORMITY

Per FCC Part 2 Section 2.1077(a)



Responsible Party Name: **Asus Computer International**

Address: **800 Corporate Way, Fremont, CA 94539.**

Phone/Fax No: **(510)739-3777/(510)608-4555**

hereby declares that the product

**Product Name : Motherboard**

**Model Number : A88XM-PLUS, A55BM-PLUS**

Conforms to the following specifications:

- FCC Part 15, Subpart B, Unintentional Radiators

### Supplementary Information:

This device complies with part 15 of the FCC Rules. Operation is subject to the following two conditions: (1) This device may not cause harmful interference, and (2) this device must accept any interference received, including interference that may cause undesired operation.

Representative Person's Name : Steve Chang / President

Signature : *Steve Chang*  
Date : Aug. 15, 2013

Ver. 120691

# EC Declaration of Conformity



We, the undersigned,

Manufacturer: **ASUSTeK COMPUTER INC.**  
Address: **4F, No. 150, LI-TE RD., PEITOU, TAIPEI 112, TAIWAN**  
Country: **TAIWAN**  
Authorized representative in Europe: **ASUS COMPUTER GmbH**  
Address: **HARKORT STR. 21-23, 40880 RATINGEN**  
Country: **GERMANY**

declare the following apparatus:

Product name : **Motherboard**  
Model name : **A88XM-PLUS, A55BM-PLUS**

conform with the essential requirements of the following directives:

### 2004/108/EC-EMC Directive

- EN 55022:2010
- EN 55024:2010
- EN 55013:2001+A1:2003+A2:2006
- EN 55020:2007+A1:2011

### 1989/5/EEC-R&TTE Directive

- EN 300 328 V1.7.1(2006-10)
- EN 300 440-1 V1.5.1(2010-08)
- EN 300 440-2 V1.5.1(2010-08)
- EN 301 511 V9.0.2(2003-03)
- EN 301 908-1 V5.2.1(2011-05)
- EN 301 908-2 V5.2.1(2011-05)
- EN 301 893 V1.6.1(2011-11)
- EN 302 544-2 V1.1.1(2009-01)
- EN 302 544-1 V1.1.1(2009-01)
- EN 302 575 V1.1.1(2009-01)
- EN 300 330-2 V1.5.1(2010-02)
- EN 300 330-1 V1.5.1(2010-02)
- EN 60979-2011
- EN 60979-2011

### 2006/65/EC-LVD Directive

- EN 60950-1 /A12:2011
- EN 60950:2002 /A12:2011

### 2004/2/EC-EPF Directive

- Regulation (EC) No. 1275/2008
- Regulation (EC) No. 642/2009

### 2011/65/EU-RoHS Directive

- CE marking



(EC conformity marking)

Position : **CEO**  
Name : **Jerry Shen**

*Jerry Shen*

Signature : \_\_\_\_\_

Declaration Date: **15/08/2013**  
Year to begin affixing CE marking: **2013**

Ver. 130268